

WORK LIGHTS



LIGHTING SOLUTIONS
FOR HIGH PERFORMANCE

LIGHTING SOLUTIONS FOR HIGH PERFORMANCE

Work light of the future

The sophisticated SCANGRIP work lights are second-to-none and made for the real professional who needs the best tool he can get for the task. The full product line-up covers all kinds of work light solutions with superior quality across the entire range. These are lights made for work and built to last.

Latest technologies for best performance

SCANGRIP constantly push back the boundaries of LED lighting and battery technology, creating new cutting-edge work lights. We always reach for that extra brightness, that extra operation time, those little touches that make a real difference when you need the best work light you can get. We guarantee to provide you with only premium products for optimal performance.

Extreme durability and functional design

SCANGRIP work lights are extremely durable and made to last and do the job again and again. The entire product line is sturdy and endures the

really demanding working environment which expose both the professional worker and his tools to rough, wet, and dirty conditions. The lights are covered by a high IP protection level to resist even outdoor use in all kinds of weather.



GO GREEN - A better choice for the climate

SCANGRIP work lights are a choice in a greener direction where the climate impact is minimized on an everyday basis. All our lighting solutions are developed to be energy saving and with a long lifetime.

Whether you compare energy efficiency with traditional technologies or other LED products, you will save energy by choosing a SCANGRIP work light. The LED PERFORMANCE indicates the ac-



tual light output of the LED in a SCANGRIP work light and we aim for the highest number to achieve less power consumption compared to other solutions on the market.

Extended warranty

Every SCANGRIP work light is manufactured at our own factories and subject to strict quality controls. Our lights meet the highest quality standards and are built to last. They are so good that we offer a warranty extension. All SCANGRIP work lights come with a 3-year warranty. Because we stand by the products we offer.

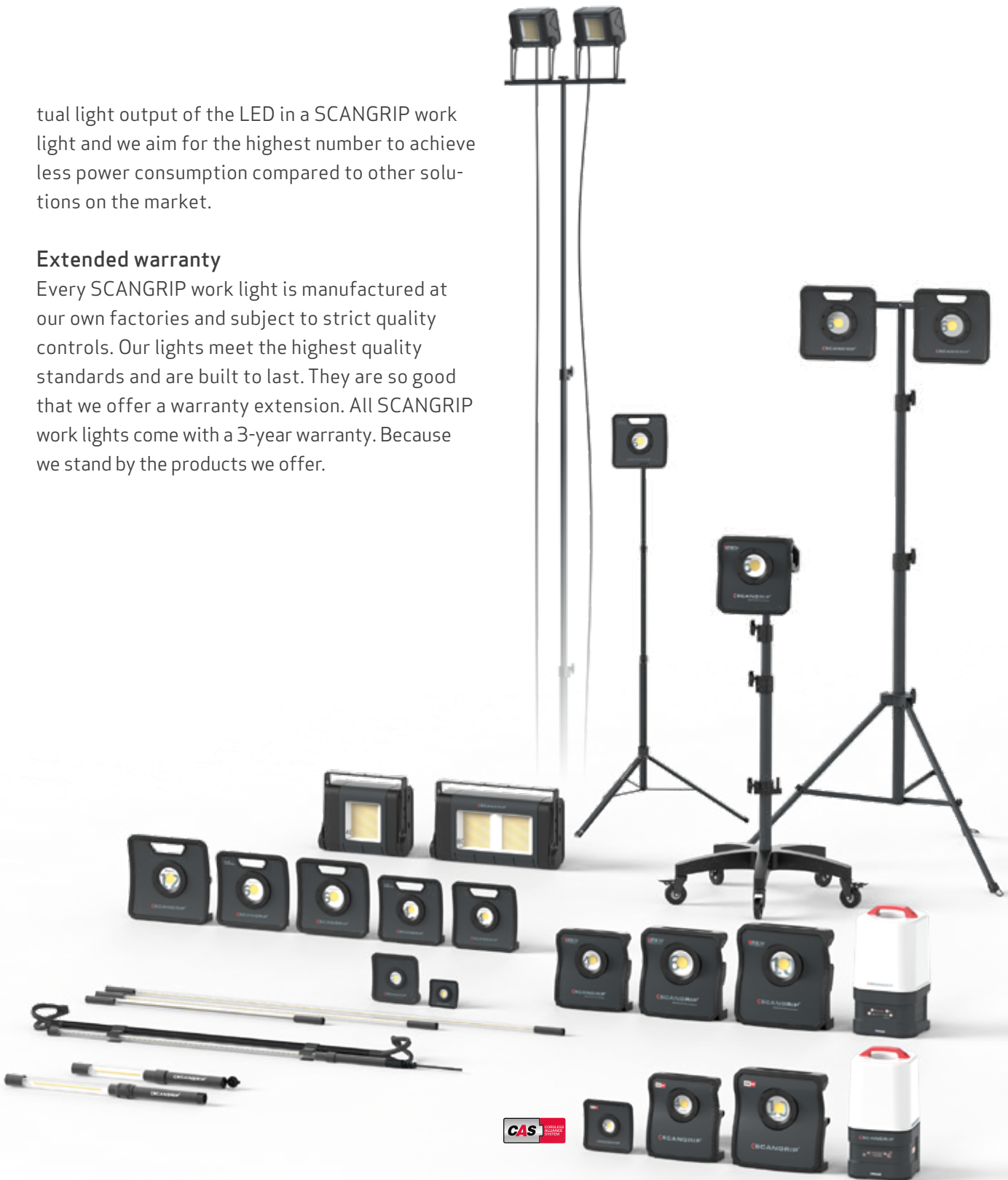

3
years
warranty
PATENT PROTECTED

Designed by us. Manufactured by us.



// The "ORIGINAL SCANGRIP" symbol is your guarantee that the product is designed, developed and made by SCANGRIP and protected by EU design patent.

High quality

SCANGRIP products are known for high quality with a price-to-quality ratio considered to be the best on the market. We have comprehensive quality check procedures, and we are ISO 9001 certified.

Unique design

SCANGRIP receives strong recognition in the marketplace for unique product design. We are inspired by the concept of Danish design and gather ideas from other industries to create new products that have not been seen before.

Europe's leading manufacturer

SCANGRIP provides the strongest and most comprehensive range of durable and functional LED work lights and is Europe's leading and trendsetting manufacturer of work lighting solutions for professionals.

First-mover

SCANGRIP is first-mover and is always two steps ahead when it comes to developing new and innovative LED work lights.

Since 1906

SCANGRIP has manufactured hand tools of very high quality for the industrial and automotive sectors for 115 years.

3
years
warranty

PATENT PROTECTED

SCANGRIP - work lights of the future



MAG series

06



UNIFORM series

08



SLIM series

10



LINE LIGHT hand lamps

12



Bonnet lights

14



Headlamps

18



STAR

22



NOVA series

24



AREA

26



STANDS and
SUSPENSIONS

36



SITE LIGHT series

38



FLASH LIGHT series

40



LINE LIGHT concept

42



LINE LIGHT for lifts

46



LINE LIGHT for
customized installation

48



Technical specifications

50

MAG - Europe's most bestselling work lights even further improved

// The rechargeable handheld work lights everybody knows - and loves! With significantly improved light output, battery upgrade and even more functionality, the popular MAG work lights offer great value in every workshop operation.

The MAG series consist of universal and powerful multipurpose work lights that all professional users must have!

- Significantly improved with higher lumen output
- Integrated work light and flashlight functionality in one
- Strong built-in magnetic holders and retractable hooks for handsfree operation
- New stepless dimmer function

ORIGINAL
SCANGRIP



SINCE 1906

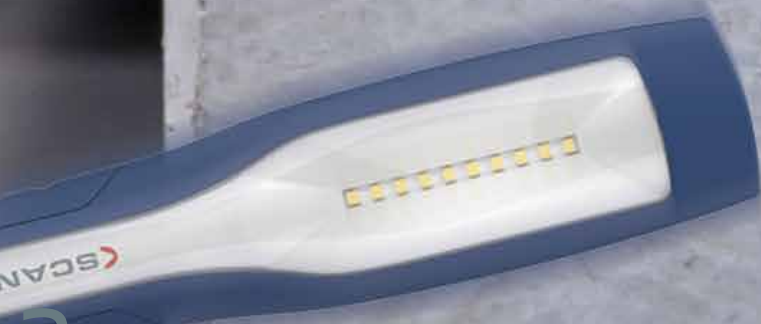

3
years
warranty

PATENT PROTECTED

// Updated and more powerful than ever

Taking advantage of the latest high performance LED technology, the MAG range comprises extremely powerful work lights providing significantly improved light output. Compared to the previous MAG 3 and MINI MAG, the new MAG PROs are upgraded to IP54 and have a new design with battery indicator on front.

// Multipurpose with cool design

The characteristic and elegant design of the MAG hand lamps provides an ergonomic and user-friendly grip. Place anywhere you want with the strong built-in magnetic holders and retractable suspension hooks to obtain complete flexibility. The lamp head is flexible and tilts up to 180 degrees.

// Stepless dimmable



MAG PRO, MINI MAG PRO and MAG PEN 3 are upgraded with a stepless dimmer function in the range of 10% to 100% that enables you to adjust the light output to the work task.



MAG

03.5400

Work light with SMD LEDs and spotlight providing 300 lumen

EU DESIGN PATENT
2954123



MAG PRO

03.5690

Work light with COB LEDs and spotlight providing 600 lumen

EU DESIGN PATENT
2954123



MINI MAG PRO

03.5692

Work light with COB LEDs and spotlight providing 200 lumen

EU DESIGN PATENT
3451038



MAG PEN 3

03.5116

Pencil work light with COB LEDs and spotlight providing 150 lumen



EU DESIGN PATENT
4070035

// Rechargeable inspection penlight

Upgraded with the highly efficient COB LED technology, MAG PEN 3 provides powerful illumination both from the lamp head and precision top light.

The design is compact allowing access in the most inaccessible places. It comes with built-in magnets both in the turnable clips and at the bottom for flexible positioning.

UNIFORM - *Extremely durable work lights*

// Upgraded to highest possible performance

SCANGRIP is introducing upgraded and improved versions of the entire UNIFORM work light series.

The COB LED strip lights provide a unique, powerful and completely uniform illumination which is ideal for all demanding work operations.

The entire series has also been upgraded to IP65.

- Rechargeable COB LED work light series
- Completely uniform and powerful illumination
- Extremely durable and sturdy
- Waterproof, IP65
- Rechargeable with USB cable



UNIFORM

03.5407

Work light with top flashlight providing up to 500 lumen



Extremely durable work lamp

In this product range UNIFORM is the big brother offering all the functionality you can dream of. Soon it will become your favourite, multifunctional work light. Extremely durable and powerful.

An intelligent battery indicator at the front keeps you informed about the battery level. 2-step operating option:

Step 1 = 100%, step 2 = 50% light output.

EU DESIGN
PATENT
2954123

Slim charging
base for easy wall
mounting



3
years
warranty

PATENT PROTECTED



UNIPEN

03.5420

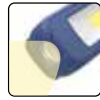

Pencil work light providing up to 150 lumen with top flashlight

Small and handy shape, supplied with pocket clip and 2-step operating option

EU DESIGN PATENT 3451038



ONLY 13mm

MINIFORM

03.5404



Pocket-sized, ultra-slim work light with top flashlight providing up to 200 lumen

With comfortable and ergonomic grip and 2-step operating option

EU DESIGN PATENT 5597010

Flexible lamp head tilts up to 180 degrees. Supplied with a strong built-in magnet and a turnable sturdy hook designed to fit the work belt.



SUPERFORM

03.5406

Sturdy work light with 5 m cable providing 750 lumen

Outperforming traditional fluorescent work lights

EU DESIGN PATENT 2954123



UV-FORM

EU DESIGN PATENT 3451038

03.5408

Work light with UV-top light (400 nm) providing up to 250 lumen



UV-FORM is a rechargeable LED work light with powerful 1.8 W UV-light on the top. The most powerful UV-light on the market. Basically you get a universal indispensable work light and UV detection in one, and at the same time it replaces special UV detection lights.

The ultraviolet light is intended for leak detection in air-conditioning systems by means of trace elements. Also useful for leak detection of larger, complex refrigeration/freezing appliances, process cooling systems, heat pump systems etc.

SLIM - Only 3-in-1 slim light on the market

// The SCANGRIP SLIM light series provides a true three-in-one, flexible and multifunctional work light for all kinds of application areas.

- 3-in-1: inspection light, work light and flashlight in one lamp
- Extremely powerful illumination up to 500 lumen with a powerful flashlight function
- Ultra-slim and compact design
- Strong built-in magnet and hook for flexible positioning
- Choose between 2 light settings (50 % or 100 %) for maximized operating time
- Rechargeable up to 6 h operation time



3
years
warranty

PATENT PROTECTED



// Ultra-slim light for inspection

The ultra-thin, compact design only $\varnothing 9$ mm allows inspection in even the most inaccessible and narrow work areas. This makes the SLIM lights ideal for very demanding and difficult inspection jobs.



// Work light in pocketsize

The 2 new SLIM lights are designed with a 100% foldable body. When fully folded the lamp can be used as a traditional handheld work light. In folded position, the SLIM is reduced to pocketsize - compact and portable to take with you everywhere.



// Flashlight function

The powerful 100 lumen spot light of the SLIM lights provides you with a flashlight function. As a unique feature, never seen before, SLIM can be used as flashlight when the lamp is folded, providing a powerful flashlight with a handy, firm grip.



EU DESIGN
PATENT
3451038



MINI SLIM

03.5610

Ultra-slim 3-in-1 inspection lamp with spotlight providing up to 200 lumen



SLIM

03.5612

Ultra-thin 3-in-1 inspection lamp with spotlight providing up to 500 lumen



ULTRA SLIM inspection hand lamps

// The sophisticated and streamlined LINE LIGHT inspection hand lamps are made in Denmark, and present a golden example of our ability to push back the boundaries of LED lighting creating work lights with optimal performance, extreme durability and lots of bright functionalities.

- Sturdy and waterproof, IP65
- Ultra-slim design (ø25 mm) allows inspection in even most inaccessible places
- Flexible positioning with adjustable hook with magnet
- Flexible gooseneck fixtures available as optional accessories

ORIGINAL
SCANGRIP



SINCE 1906

MADE IN DENMARK

3
years
warranty

PATENT PROTECTED



EU DESIGN
PATENT
4070035



Both lamps are delivered with adjustable hook with clip holder and magnet

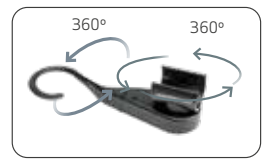

NEW

Upgraded version

LINE LIGHT C+R

03.5243

Inspection work lamp with DUAL SYSTEM and top spotlight providing up to 900 lumen



NEW

Upgraded version

LINE LIGHT R

03.5244

Rechargeable inspection work lamp with spotlight providing up to 600 lumen



The very slim design with a diameter of only 25 mm makes it possible to illuminate even hard to reach compact areas.

DUAL 2 in 1 SYSTEM

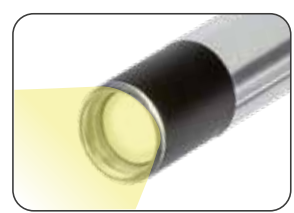

LINE LIGHT *bonnet light*

// Superior bonnet light on the market

- Improved light output (1400 lumen)
- Dust and waterproof, IP65
- Most slim and compact bonnet light on the market
- Extremely low weight, less than 1000 g
- Choose between 2 light settings (50 % or 100 %) for maximized operating time

DUAL 2 in 1 **SYSTEM**

DUAL SYSTEM is new intelligent and innovative lighting functionality.

The new BONNET LIGHT is with DUAL SYSTEM which means both rechargeable and with 5 m rubber cable offering unlimited application possibilities and complete freedom. Very easily you change over: it takes only a second to connect the power cable – or disconnect when needed.

ORIGINAL
SCANGRIP



SINCE 1906

MADE IN DENMARK

3
years
warranty

PATENT PROTECTED



EU DESIGN
PATENT
4070035



// Illuminates the entire engine bay

The BONNET LIGHT provides you with an extremely bright and powerful illumination of the entire engine bay.

Supplied with an adjustable telescopic holder with soft-padded hook ends providing a firm and scratch-free grip on the vehicle. The holder is compact and takes up less space in storage.



Without cable the bonnet light might also to be used as a large inspection lamp.



NEW

Upgraded
version

LINE LIGHT BONNET C+R

03.5240

DUAL 2 in 1 SYSTEM



Inside the cabin the BONNET LIGHT may also be used as work light either mounted by the telescopic holder or mounted onto the windscreen by the flexible arm with suction cup.



// FLEXIBLE suspensions

A range of accessories are available to position the LINE LIGHT lamps



GOOSENECK

03.5219

20 cm flexible arm
with clip holder and
ø60 mm suction cup



GOOSENECK

03.5218

20 cm flexible arm
with clip holder and
ø60 mm magnet

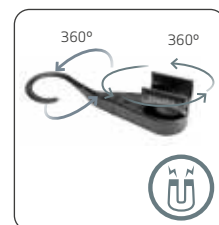

HOOK

03.5312

Adjustable hook
with clip holder
and magnet

NOVA BONNET - *Powerful bonnet light providing maximum flexibility*

// The NOVA BONNET light provides you with increased flexibility and bright illumination of the engine bay. With the NOVA BONNET, you will have a bonnet light and a flexible NOVA R hand lamp in one single solution.



Use the NOVA BONNET inside the cabin



Use NOVA R separately for inspection work



3
years
warranty

PATENT PROTECTED

// Rechargeable and dimmable COB LED work light

Easily mount the NOVA R on the bonnet light via the enclosed bracket, slide it from side to side to position the light and adjust the light output or simply use the hand lamp for inspection work.

Featuring the latest high-performance COB LED technology, NOVA R provides up to 2000 lumen with a uniform and even illumination. The light dimmer function makes it possible to adjust the light into five different levels, and due to the upgraded battery capacity, you can use the lamp for up to 20 hours depending on the light output.

The NOVA BONNET is supplied with an adjustable telescopic holder (1.2-1.7m) with soft-padded hook ends providing a firm and scratch-free grip on the vehicle. The holder is compact and equipped with a metal bracket. The powerful integrated magnets of NOVA R provides flexible mounting on the bracket. Inside the cabin, the NOVA BONNET may also be used as work light mounted by the telescopic holder.

// High flexibility

The simple and user-friendly design makes it easy to mount and dismount the NOVA R, which allows you to use the lamp for inspection work. NOVA R is easy to carry and is ergonomically designed for a good grip on the handle.



Mount and dismount NOVA R on the bracket



NOVA BONNET

03.5457



NOVA R 1000 / 2000 lumen

// ACCESSORIES

Buy accessories separately and transform your NOVA R handlamp into a flexible bonnet light.

BRACKET

03.5760



BONNET HOLDER

03.5314

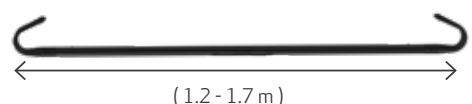

HEADLAMPS *for professionals*

// Pursuing the vision of designing innovative work light for the professional end-user

- Illuminates your entire workspace
- Rechargeable
- Long duration time
- Easy to operate
- Sensor function with touchless on/off switch

As opposed to all other headlamps providing a beam of light, the new I-VIEW and ZONE headlamps are designed to provide optimum work light illuminating your entire work area.

Supplied with the newest COB LED technology, both headlamps provide an extremely powerful illumination which spreads the uniform light to the maximum and lightens up your entire field of view.

You avoid turning the head to illuminate your actual workspace from a limited headlamp beam.

ORIGINAL
SCANGRIP



SINCE 1906

3
years
warranty

PATENT PROTECTED

NEW

Upgraded version

I-VIEW

03.5626

EU DESIGN PATENT
2635946



// Rechargeable I-VIEW with touchless sensor



I-VIEW is upgraded with the very newest rechargeable battery technology, providing extremely powerful illumination up to 400 lumen in a new modern design. When set on sensor mode I-VIEW is switched on/off only by waving a hand in front of the lamp.



It is supplied with stepless dimmer function for adjustable light output and a battery indicator. The design is ergonomic and lightweight for a perfect, comfortable fit, and the woven band is strong and adjustable. Dust and water-proof (IP65). As optional accessory, the SCANGRIP POWERBANK 03.5782 can be used for increased operating time.



// Extend the operating time

SCANGRIP POWERBANK is specially developed for I-VIEW as an optional accessory which extends the total operating time to 5.5 hours at full power.

ZONE

03.5426



EU DESIGN PATENT
3451038

// Rechargeable ZONE headlamp

The ZONE headlamp is designed to provide optimum work light illumination of the entire work area, like the I-VIEW.

ZONE is designed for professional use, it is sturdy and low weight of only 84 g. With its very attractive price, ZONE will become another SCANGRIP bestseller.

ZONE has been upgraded to provide 75/150 lumen.

STANDARD HEADLAMP



I-VIEW and ZONE HEADLAMPS



NIGHT VIEW - *for work in the dark*

// New headlamp that keeps your night vision

- Designed for work in the dark
- Rechargeable with touchless sensor function
- Illuminates your entire work space
- Durable, sturdy and waterproof
- Switch between normal white light and red light



3
years
warranty

PATENT PROTECTED

// Choose between white and red work light

The red light is intended for work in the dark and provides light without overexposing the retinas while at the same time keeping the eyes adjusted to the dark.

The red-light functionality is mostly known from the military to read maps on maneuvers at night, but is also needed in civilian professions for work at night, for instance on ships and offshore. On ships it is particularly useful on the bridge at night, because it preserves your night vision so you can work at the control panel. Headlamps with red-light mode are also well suited for security guards that work at night in dark surroundings.

// Newest lighting technology

The NIGHT VIEW provides extremely powerful illumination which spreads the uniform light to the maximum and lightens up your entire field of view. You avoid turning the head to illuminate your actual workspace from a limited headlamp beam.

NIGHT VIEW is provided with the very newest rechargeable battery technology with extraordinary long duration, and sets new standards for professional work light. When set on sensor mode NIGHT VIEW is turned on/off only by waving a hand in front of the lamp. Thus, the light can easily be switched on/off, even when wearing thick gloves.



Keep your night vision

NIGHT VIEW

03.5438

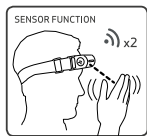

STANDARD HEADLAMP



NIGHT VIEW HEADLAMP



6000 K



632 nm

EU DESIGN PATENT
2635946



STAR - Work light and floodlight in one

// STAR is the missing link between a work light and a floodlight. It is a new multifunction work light that does it all!

- Extremely powerful illumination, up to 1000 lumen
- Rechargeable up to 5 h operation time
- Waterproof IP65
- Ergonomic design for a comfortable, firm hand grip
- Flexible handle for multifunctional positioning and application
- Sturdy handle with built-in magnet
- Direct mounting on the SCANGRIP TRIPOD
- Durable housing made of shock-resistant plastic material
- Built-in powerbank



ORIGINAL
SCANGRIP



SINCE 1906

3
years
warranty

PATENT PROTECTED

// Multifunctional work light

STAR is designed to be the work light that does it all. The lamp is ergonomically designed to be used as a hand held work light. Extending the position of the handle, the lamp transforms itself to be a searchlight.

// Handy floodlight

Due to the extremely powerful light output, STAR is also applicable for illumination of a larger working area, in spite of its small size compared to other floodlights. The handle is designed for direct mounting on the SCANGRIP TRIPOD.

// Flexible positioning

Due to the flexible handle the STAR can stand in different positions to obtain the optimal lighting angle for a specific work task. The handle is also clickable in fixed position to serve as a hook for suspension. Using the powerful built-in magnet in the handle the STAR can be placed in flexible positions on any metalized surface.



EU DESIGN
PATENT
3451038



// Powerbank

Built-in power bank with USB outlet to charge mobile devices.



Flexible positioning



STAR

03.5620



Position the light directly on the SCANGRIP TRIPOD up to 3 m

Handheld work light



NOVA range – world's best work lights for the professional user

// SCANGRIPs range of NOVA work lights are the best, most powerful and sturdy COB LED work lights on the market at all. Made to last and do the job again and again. Even coming with an extended 3-year warranty like all our WORK LIGHTS for high performance.

- Most sturdy and durable work lights made for ROUGH SERVICE USE
- Extremely powerful illumination, up to 12.000 lumen
- Light dimmable in 5 steps
- Waterproof (IP67) for all kinds of outdoor weather conditions
- Stands and suspensions for flexible lighting positioning



ORIGINAL
SCANGRIP
SINCE 1906

3
Years
Warranty

PATENT PROTECTED

// NOVA work lights for every working situation

The NOVA range provides the widest range of durable work lights in the world. So, you just choose your favourite NOVA model between the various models. And choose if your NOVA should be portable, rechargeable, with exchangeable batteries or with cable.

// Extreme durability

All NOVAs are made of die casted aluminium which makes them extremely sturdy and shockproof. Also, the NOVAs are designed to endure the rough, wet and dirty conditions of the professional working environment, and withstand even outdoor work in all kinds of weather conditions, as they are completely waterproof (IP67).

// Designed for efficient workshop use

The COB (chip on board) LED provides a uniform and completely even illumination with colour temperature close to daylight which is particularly effective as work lighting. The light dimmer function makes it possible to adjust the light into different levels.

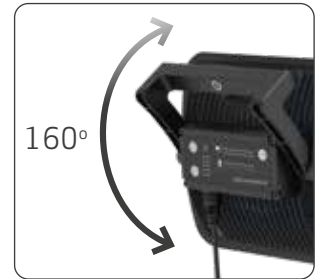

Flexible stand



Slim design

// Various NOVA models

Rechargeable and portable



1000 / 2000 lumen

Rechargeable with DUAL SYSTEM



4000 / 6000 lumen

With cable



4000 / 6000 / 12000 lumen

Rechargeable with DUAL SYSTEM and SCANGRIP POWER SOLUTION exchangeable batteries



4000 / 6000 / 10000 lumen

Rechargeable with METABO/ CAS battery system



2000 / 4000 / 10000 lumen

DUAL 2 in 1 SYSTEM

SPS7//
SCANGRIP POWER SOLUTION

DUAL 2 in 1 SYSTEM

CAS COMPLETE BATTERY SYSTEM

Durable work lights designed for ROUGH SERVICE USE

NOVA MINI – *Extremely compact handheld work light*

// With its extremely compact and unique design, the NOVA MINI is a brand-new hand held floodlight that is the ultimate “must-have” for professionals in all industries.

- Ultra-slim and compact design
- Extremely powerful illumination, up to 1000 lumen
- SMART GRIP 4-in-1 system for a comfortable, firm hand grip and flexible positioning
- Stepless dimmer function
- Charging indicator



3
years
warranty

PATENT PROTECTED





// Small-sized with super powerful illumination

Featuring the latest LED technology, NOVA MINI is incredibly powerful and provides up to 1000 lumen – which is absolutely unique for such a small lamp. NOVA MINI is supplied with a practical on/off button on the side that is also acting as a light control. Adjust the light output with the stepless dimmer function in the range of 10 % to 100 %.

As part of the popular NOVA family, NOVA MINI is based on all the same unique and well-known features that the NOVA series is known for. With its compact dimensions, it is more than twenty times smaller than the NOVA 12K and fits perfectly into your pocket.

// SMART GRIP 4-in-1 system

The lamp is supplied with a special, patented SMART GRIP 4-in-1 system that integrates several multi-functions in the same unit. The ring is based on the functionality you know from e.g. mobile phones which makes it easier and more convenient to keep the lamp in your hand for a long time. It relieves the muscles and increases ergonomics.

The clip is designed to fit the work belt and carry the lamp the entire day, and when both hands are needed for a task, the strong built-in magnet can be used for flexible positioning. Furthermore, SMART GRIP can be used as a stand on any available surface.

pat. pend.
SMART GRIP 4 in 1



NOVA MINI

03.6010



A charge indicator on the side of the lamp keeps you informed about the battery level.

NOVA Handlamps – Portable, rechargeable work lights

// The handheld NOVA work lights provide powerful illumination and long operating time – perfect to carry around from job to job.

- Rechargeable COB LED work lights, up to 2000 lumen
- Ultra-slim and compact design
- Light dimmable in 5 steps
- Flexible positioning
- Built-in powerbank



// Handlamp compatible with METABO/CAS battery system

NOVA 2 CONNECT is compatible with 12V - 18V METABO/CAS batteries, and at the same time, the SCANGRIP POWER SUPPLY can be used for direct power, providing unlimited availability to light. It is supplied with a flexible stand and built-in hook.

EU DESIGN PATENT 213346



Change battery - can be used with 12V - 18V batteries

Convert NOVA 2 CAS lamp to a corded model with the SCANGRIP POWER SUPPLY

NOVA 2 CONNECT

Compatible with METABO / CAS battery system 12V - 18V

03.6100C

Work light excluding battery and charger



Hook for flexible positioning

OPTIONAL ACCESSORIES

CAS BATTERY 12V 4.0 Ah Item no. 03.6120

CAS BATTERY 18V 5.2 Ah Item no. 03.6121

CAS CHARGER Item no. 03.6122

SCANGRIP POWER SUPPLY Item no. 03.6123

3 years warranty

PATENT PROTECTED

EU DESIGN
PATENT
4070035



// Portable and universal work lights

The NOVA handlamps are universal all-round work lights designed for the professional user. They feature the latest high-performance COB LED technology and provide up to 2000 lumen with a uniform and even illumination. The light dimmer function makes it possible to adjust the light into five different levels.

The durable construction approves the NOVA handlamps to ROUGH SERVICE USE which makes them perfect for the demanding, rough working environment.



As an extra feature, they are also supplied with a built-in powerbank with USB outlet to charge mobile devices.



Light dimmable in 5 steps

// Multifunctional design for high flexibility

NOVA R is easy to carry and is ergonomically designed for a good grip on the handle, which is also equipped with powerful integrated magnets for flexible mounting. Due to the flexible handle, NOVA R can be placed in different positions to obtain the desired lighting angle. The handle is also designed for direct mounting on the TRIPOD or the SCAFFOLDING BRACKET.



NOVA R

03.5456



NOVA – *The world's most durable work lights*

// The original NOVA work lights are the best, most powerful and sturdy COB LED work lights on the market at all. These are universal work lights for the most challenging lighting operations in every rough and demanding working environment.

- Rechargeable versions with advanced DUAL SYSTEM
- Display for battery capacity and remaining operating time
- Integrated carrying handle
- BLUETOOTH light control app for NOVA 12K



3
years
warranty

PATENT PROTECTED



// Designed for efficient workshop use



The light dimmer function makes it possible to adjust the light into five different levels. With the integrated carrying handle, it is convenient to hand carry the lamp. The flexible stand can be used as a hanger and to position the lamp in the desired lighting angle. The stand is designed for direct mounting on the SCANGRIP TRIPOD.

EU DESIGN
PATENT
2954123



// Rechargeable NOVAs

The NOVAs with the unique DUAL SYSTEM are both rechargeable and with cable providing you unlimited application possibilities. The DUAL SYSTEM connection is improved for easier and faster mounting and disconnecting the cable. The rechargeable versions are also supplied with a user-friendly display showing both battery capacity and the remaining operating time.



NOVA 4K C+R

03.5441

Work light with DUAL SYSTEM providing up to 4000 lumen

DUAL 2 in 1 SYSTEM



NOVA 6K C+R

03.5443

Work light with DUAL SYSTEM providing up to 6000 lumen

DUAL 2 in 1 SYSTEM



// NOVAs with cable

The NOVA range offers 3 cable models, all providing extremely powerful illumination. With a light output of up to 12000 lumen, NOVA 12K is designed for the most challenging lighting operations.

With the integrated BLUETOOTH light control feature you can easily control up to four work lights. The light control also makes it possible to turn on/off the lamp and adjust the light output to suit the work task in question. The BLUETOOTH application is perfect when working with one or more hard-to-reach lamps, for example positioned on the SCANGRIP TRIPOD.



LIGHT CONTROL



NOVA 4K

03.5440

Work light with 5 m cable providing up to 4000 lumen



NOVA 6K

03.5442

Work light with 5 m cable providing up to 6000 lumen



NOVA 12K

03.5444



Work light with BLUETOOTH and 5 m cable providing up to 12000 lumen

NOVA - Powerful illumination and exchangeable battery pack

// The most powerful and sturdy work lights with exchangeable battery pack providing unlimited availability to light.



- Innovative battery systems – rechargeable with exchangeable battery or with power supply
- Integrated backup battery functionality
- Display for battery capacity and remaining operating time
- BLUETOOTH light control app with extended functionality

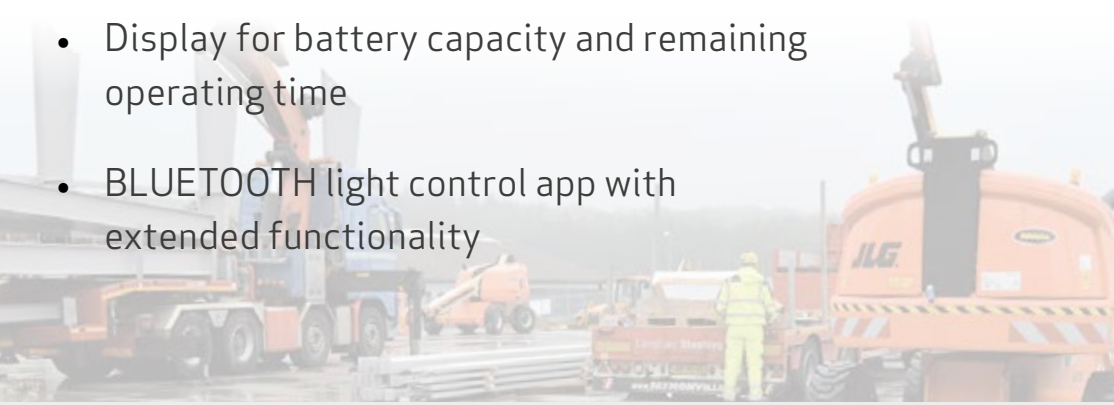

EU DESIGN PATENT 213346

NOVA 4 CONNECT

03.6101C

Compatible with METABO / CAS battery system 12V - 18V

 Work light with BLUETOOTH providing up to 4000 lumen
Excluding exchangeable battery and charger

Other product versions available - see page 58-59

NOVA 10 CONNECT

03.6102C



Compatible with METABO / CAS battery system 12V - 18V

 Work light with BLUETOOTH providing up to 10000 lumen.
Excluding exchangeable battery and charger



Incl. diffuser which spreads the light and improves working conditions

OPTIONAL ACCESSORIES

-  CAS BATTERY 12V 4.0 Ah Item no. 03.6120
-  CAS BATTERY 18V 5.2 Ah Item no. 03.6121
-  CAS CHARGER Item no. 03.6122
-  SCANGRIP POWER SUPPLY Item no. 03.6123

3 years warranty

PATENT PROTECTED



Use battery charger directly on the lamp as power supply



Change battery



Charging exchangeable battery

EU DESIGN PATENT 5597010

// Flexible battery systems

The NOVA floodlights are available in different versions depending on which type of battery system you prefer. Both the SCANGRIP POWER SOLUTION and METABO/CAS battery systems provide high flexibility and unlimited availability to light. You can easily exchange the battery or simply add the power supply directly to the lamp to get power supply. They also both feature an integrated battery backup function and are supplied with a built-in power bank with USB outlet to charge mobile devices.



Built-in powerbank

With the METABO/CAS battery system, you can use the same battery among different power tools that are compatible with METABO/CAS.



// Always light. Never left in the dark

No matter how limited your access is to power supply both the SPS and METABO/CAS battery systems ensure that you always have the necessary light to carry out your job. The NOVA floodlights provide complete freedom, flexibility and maximum work efficiency.



NOVA 4 SPS

03.6000

- Work light with SPS and BLUETOOTH providing up to 4000 lumen. Incl exchangeable battery and charger



NOVA 6 SPS

03.6001

- Work light with SPS and BLUETOOTH providing up to 6000 lumen. Incl exchangeable battery and charger



NOVA 10 SPS

03.6002

- Work light with SPS and BLUETOOTH providing up to 10000 lumen. Incl exchangeable battery and charger

BLUETOOTH - Light control app

- Dimmer light output into 5 levels 10 %-100 %
- Switch on/off, check battery
- Group control function, up to 4 lamps
- Assign pin code

Compliant with iPhone 5 or higher / Android 5.0 or higher. Go to iTunes App Store to download the app or download the app from scangrip.com

Always light. Never left in the dark.

AREA 10 – 360° work light with exchangeable battery



// AREA 10 provides a diffused and uniform light and is ideal for the professional user who requires powerful and efficient illumination of the entire work site.

- Diffused, non-blinding light, up to 10000 lumen
- Portable due to compact design and low weight
- Supplied with exchangeable battery pack – choose between SCANGRIP POWER SOLUTION or METABO/CAS battery system
- Integrated backup function – up to 1h use with 1000 lumen without battery or cable
- Dimmable in five steps
- User-friendly BLUETOOTH light control app

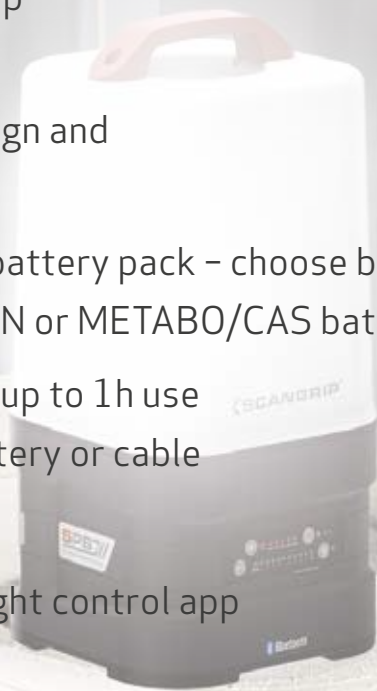

Change between 360° and 180° illumination



Change battery



Use SCANGRIP POWER SUPPLY for direct power

AREA 10 CONNECT

Compatible with
METABO / CAS
battery system
12V - 18V

03.6103

-  360° work light with BLUETOOTH providing up to 10000 lumen
Excluding exchangeable battery and charger

Other product versions available - see page 60

EU DESIGN
PATENT
213346

OPTIONAL ACCESSORIES



CAS BATTERY
12V 4.0 Ah
Item no. 03.6120



CAS BATTERY
18V 5.2 Ah
Item no. 03.6121



CAS CHARGER
Item no. 03.6122



SCANGRIP POWER SUPPLY
Item no. 03.6123

3
years
warranty



// Powerful illumination of the entire work site

AREA 10 provides a diffused and non-blinding work light with large dispersion. You can change between 360° and 180° illumination according to the work task and adjust the light output into five different levels by the built-in dimmer function. The compact design with a carrying handle makes AREA 10 extremely handy and easy to move around. It is also supplied with a hook for flexible positioning and can be mounted directly on the SCANGRIP TRIPOD.

// High flexibility and long operating time

AREA 10 is available in two different versions depending on which type of battery system you prefer. Both the SCANGRIP POWER SOLUTION and METABO/CAS battery systems provide high flexibility and unlimited availability to light. You can easily exchange the battery or simply add the power supply directly to the lamp to get power supply. They also both feature an integrated battery backup function and is supplied with a built-in power bank with USB outlet to charge mobile devices. With the METABO/CAS battery system, you can use the same battery among different power tools that are compatible with METABO/CAS.

// BLUETOOTH light control

With the integrated BLUETOOTH light control, you get an extraordinary possibility to turn on/off the work light and adjust the light output through your mobile device. This feature saves time from manual operation and increases work efficiency on a daily basis.



EU DESIGN
PATENT
7180187



BLUETOOTH - Light control app

- Dimmer light output into 5 levels 10 %-100 %
- Change between 360° and 180° illumination
- Switch on/off, check battery
- Group control function, up to 4 lamps
- Assign pin code

Compliant with iPhone 5 or higher / Android 5.0 or higher. Go to iTunes App Store to download the app or download the app from scangrip.com



AREA 10 SPS



03.6009



360° work light with SPS and BLUETOOTH providing up to 10000 lumen Incl. exchangeable battery and charger.



Exchange battery or use battery charger directly on the lamp as power supply



Built-in hook for flexible positioning



Built-in powerbank

STANDS and SUSPENSIONS



// Designed for direct mounting of NOVA and CAS work lights as well as STAR and AREA 10 SPS without bracket. Made of durable and sturdy powder coated steel for both indoor and outdoor use

// High stability tripod

The SCANGRIP TRIPOD is indispensable for stationary positioning of the work light for illumination in a specific working area. The SCANGRIP TRIPOD is extendable from only 1.35 m up to 3 m which gives you complete flexibility to position the light in the requested height.

The stable construction of the SCANGRIP TRIPOD 3M makes it safe even when fully extended. It is supplied with anchor points that provide an opportunity for extra stability if the tripod is exposed to strong wind or standing on an uneven surface. To increase safety when in use, the cable of the lamp can be fixed in the safety clips placed on each separate leg.

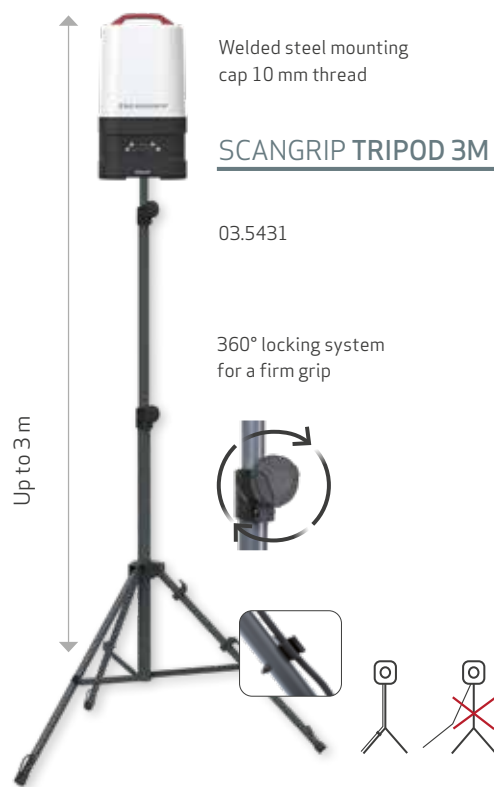

SCANGRIP TRIPOD 3M

03.5431

360° locking system for a firm grip

// Lightweight TRIPOD with QUICK RELEASE function



With its lightweight and extremely handy design, the SCANGRIP TRIPOD 2M is indispensable for stationary positioning of the work light for illumination in a specific working area. The tripod is extendable from 0.9 meter up to 2 meters, which gives you complete flexibility to position the light in the requested height. When mounted on the tripod the light can be tilted to provide the optimum beam angle.

Featuring a compact design and QUICK RELEASE function, it is easy and convenient to carry the tripod and set it up where illumination is needed. The tripod is extremely durable and can be applied for both indoor and outdoor use. The stable construction makes it safe even when fully extended. It is made of black painted aluminum.

QUICK RELEASE function



SCANGRIP TRIPOD 2M

03.5685

2.1 kg
Max load 5 kg

0.78 m
Lightweight
Easy to carry

DUAL BRACKET not applicable.

// Wheel stand for mobile positioning

The SCANGRIP WHEEL STAND makes it easy to move the light to where you need it, and at the same time you avoid uncomfortable and heavy lifting from one workplace to the other. It is upgraded with a new base which is equipped with 5 wheels for improved safety and stability and easy maneuverability.



As an additional feature, it now comes with a flexible bracket that enables you to easily position a second work light to illuminate from below. The extra mounting bracket is adjustable in the height and provides complete flexibility to position the light in the optimum height.



// Suspensions for flexible positioning

DUAL BRACKET

03.5308



Dual bracket for positioning of two lamps on TRIPOD or WHEEL STAND

SCAFFOLDING BRACKET

03.5341



For flexible positioning on scaffoldings or any round object \varnothing 40-50 mm

MAGNET BRACKET

NEW

Upgraded version

03.5390



For flexible positioning of the work light on any magnetic surface

NEW

Upgraded version

MAGNET BRACKET - Large

03.5391



For flexible positioning of NOVA 12K, NOVA 6 SPS, NOVA 10 SPS and NOVA 10 CAS on any magnetic surface

// SCANGRIP DIFFUSER provides a large dispersion and spreads the light

Enlightens the entire working area, even into the darkest corner and softens the light avoiding hard shadows. Minimizes reflections and harsh light and provides non-blinding work light.



Easy and safe mounting with strong magnets

SCANGRIP DIFFUSER

03.5750

Fits NOVA 4K, NOVA 4K C+R, NOVA 4 SPS and NOVA 4 CAS

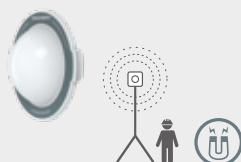

SCANGRIP DIFFUSER - Large

03.5751

Fits NOVA 6K, NOVA 6K C+R, NOVA 12K, NOVA 6 SPS, NOVA 10 SPS and NOVA 10 CAS



SITE LIGHT – high-performance construction site lights

// SCANGRIP presents new, powerful SITE LIGHT work lights that are made in Denmark and provide extremely high light output at a very attractive price.

The SITE LIGHTs feature active cooling and have a long lifetime. Available in two variants providing 40000 lumen and 80000 lumen.

- Powerful illumination with wide beam angle
- Light dimmable in 4 steps
- BLUETOOTH light control
- Compact and low weight
- Waterproof (IP65) for all kinds of outdoor weather conditions



NEW

SITE LIGHT 80

Upgraded version

03.5269



Large area light with BLUETOOTH and dimmer function providing up to 80000 lumen

NEW

SITE LIGHT 40

Upgraded version

03.5268



Large area light with BLUETOOTH and dimmer function providing up to 40000 lumen

3
years
warranty

PATENT PROTECTED

ORIGINAL
SCANGRIP



SINCE 1906

MADE IN DENMARK



EU DESIGN
PATENT
7180187

Bluetooth®

BLUETOOTH - Light control app

- Dimmer light output into 4 levels
- Switch on/off
- Group control function, up to 4 lamps
- Assign pin code



Compliant with iPhone 5 or higher / Android 5.0 or higher. Go to iTunes App Store to download the app or download the app from scangrip.com

// Powerful illumination and BLUETOOTH light control

Based on the newest state-of-the-art LED technology, the SITE LIGHTs provide an extremely high light output and a wide 120° beam angle, ensuring super bright illumination of a large work area. The dimmer function enables you to adjust the light in four different levels, and by using the BLUETOOTH light control app, you can turn on/off the work light and adjust the light remotely through your mobile device. When the work lights are mounted on high masts, this feature reduces the power consumption on an everyday basis as you only use the amount of light necessary to do the job.

// Compact design for easy mounting



The SITE LIGHTs are designed with a built-in handle for easy carrying and mounting on tripod and masts. They are extremely compact and low weight compared to other solutions on the market, which makes the mounting of the work lights more convenient. The SITE LIGHTs come with

10-meter cable and include a DIN14640 connection adapter with bracket for mounting on a tripod.

// Built to do the job at the construction site

The SITE LIGHTs are completely dust and waterproof (IP65) and tolerate all kinds of weather conditions from -25° to +40°C. Featuring high-quality components and active cooling, the work lights have a long lifetime and keep a high performance level throughout the day.



**TRANSPORT CASE
SITE LIGHT 80**

49.0351

**TRANSPORT CASE
SITE LIGHT 40**

49.0350

The transport cases enable you to safely transport your SITE LIGHT work light to the building site. They are sturdy and high-quality cases that can withstand shocks and rough handling during transport.

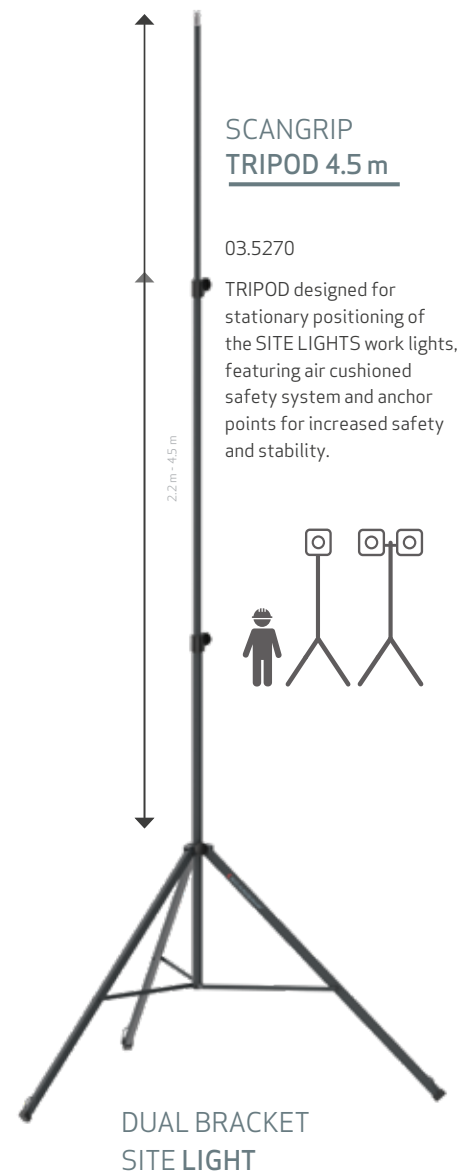

**SCANGRIP
TRIPOD 4.5 m**

03.5270

TRIPOD designed for stationary positioning of the SITE LIGHTs work lights, featuring air cushioned safety system and anchor points for increased safety and stability.

**DUAL BRACKET
SITE LIGHT**

03.5758



Dual bracket for positioning of two SITE LIGHTs

FLASHLIGHT *series*

// SCANGRIP provides the strongest and most comprehensive range of LED work lights on the market. We are now proud to present an upgraded and re-designed flashlight series providing extremely high light output and improved functionality for an even better user experience.

The new flashlights are available both as rechargeable and with batteries, providing brand-new features and accessories to increase work efficiency.

- BOOST MODE
- Practical clip-on holster for the work belt
- One-hand operated magnetic switch
- Higher lumen output
- Long operation time

// Dimmable keychain light with integrated USB charger cable

FLASH MICRO R is an ultra-compact and bright LED keychain light that provides up to 75 lumen and designed to take with you everywhere you go in the pocket.

The integrated USB charger cable is a new smart technology that allows you to easily recharge the light directly in the USB port of your computer and other devices without using a separate charger.



FLASH MICRO R

03.5113



FLASH MICRO R comes in a display of 12 pcs.

ORIGINAL
SCANGRIP



SINCE 1906

3
years
warranty

PATENT PROTECTED

Boost mode

The new flashlight series is supplied with a BOOST MODE enabling you to double the lumen output with a simple one-hand operation. Push the magnetic, electronic switch for two seconds to activate boost mode.

The flashlight automatically turns to normal mode after 60 seconds.



Clip-on holster

Sturdy and practical clip-on holster for the work belt for easy carrying everywhere you go. Compared to the nylon belt pouch, the new clip-on holster provides free access to the flashlight. You simply put the flashlight into the holder and rotate it to lock it in place.

Can also be mounted on the edge of a workbench for easy storage.



Focus function

By means of the focus function you can vary the beam angle, from concentrated and focused light beam angle to long-distance light.

Ergonomic design

The elegant, fine grooved metallic surface of the flashlights provides an ergonomic, firm and user-friendly grip.

High durability

The housing is made of anodised aluminum with a high impact resistance making the flashlights extremely sturdy and durable. Waterproof, IP54.

Wrist strap

The soft and handy silicone wrist strap provides a secure operation while keeping the flashlight close at hand at all time.

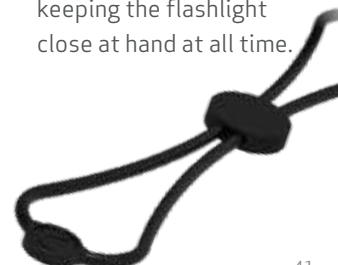

FLASH series with batteries

// The new durable flashlight series with Alkaline batteries is designed for the rough and demanding work environment providing high-quality flashlights for all types of inspection tasks.

EU DESIGN
PATENT
7180187

FLASH 300 and FLASH 600 include a silicone wrist strap and clip-on holster.

BOOO

NEW



Powerbank with battery indicator

Designed for the I-VIEW headlamp but can be used for recharging any SCANGRIP work light as well as other devices. Featuring battery indicator and intelligent load detection. Modern and durable design.

SCANGRIP POWERBANK

03.5782
4000mAh aluminum powerbank

The new ultra-slim FLASH PENCIL

A must-have for everybody doing daily inspection tasks. It is so thin, only $\varnothing 15$ mm. Supplied with a clip and designed to always have in the chest pocket, right at your fingertips.

Weighing only 32 g the FLASH PENCIL is incredibly lightweight.

FLASH PENCIL

03.5130
Ultra-slim pencil flashlight providing 75 lumen



FLASH PEN

03.5131
Pencil flashlight with boost mode providing up to 200 lumen

FLASH 300

03.5132
Flashlight with boost mode providing up to 300 lumen

FLASH 600

03.5133
Flashlight with boost mode providing up to 600 lumen

3
years
warranty

PATENT PROTECTED

Rechargeable FLASH R series

EU DESIGN
PATENT
7180187

// Sturdy and powerful flashlights of extraordinary high quality providing extremely bright illumination and durability. Easily recharged by the enclosed USB cable.

FLASH 1000 R and FLASH 600 R include a silicone wrist strap and clip-on holster.

The new WORK PEN 200 R is a real work light for professional inspection work. It is extremely powerful for its small size. Supplied with a clip for the chest pocket and built-in magnets for flexible positioning.



Pocket sized FLASH 12-24V

With a new brushed-up look, the FLASH 12-24V is designed to easily charging directly from the cigarette lighter socket in your car. No need of charger device, cable, or batteries!

FLASH 12-24V

03.5124

Rechargeable flashlight providing 130 lumen



FLASH 1000 R

03.5138

Rechargeable flashlight with boost mode providing up to 1000 lumen

FLASH 600 R

03.5137

Rechargeable flashlight with boost mode providing up to 600 lumen

FLASH PEN R

03.5136

Rechargeable pencil flashlight with boost mode providing up to 300 lumen

WORK PEN 200 R

03.5127

Rechargeable LED penlight providing up to 200 lumen



LINE LIGHT - *Unique lighting concept*

// LINE LIGHT is a flexible lighting solution for universal application designed for use anywhere where strong, efficient and concentrated light in a specific working area is needed. Now in a new upgraded version with double lumen output.

- Most competitive solution on the market
- “Unbreakable” - extremely sturdy and shockproof
- Waterproof to resist wet and dirty workshop environment
- Low voltage 24 VDC
- Technical lifetime of LEDs 100,000 hours
- Made in Denmark



ORIGINAL
SCANGRIP



SINCE 1906

MADE IN DENMARK

3
years
warranty

PATENT PROTECTED



// Bright illumination exactly where you need it

By means of a built-in prism, LINE LIGHT concentrates the light in a 75° beam angle providing an extremely bright and powerful illumination of the specific working area. Blinding during work is avoided, and the lamp itself can be turned to provide the optimum lighting angle.

// Innovative LED technology

The LINE LIGHT series is based on the newest state-of-the-art LED technology and provides much more light compared to the traditional 36 W fluorescent tubes which are commonly used within the industry.

The quality of the light is extremely powerful, like daylight which is optimum for precise recognition of colours, shades and other product details. The uniform, flicker free illumination without strobe effects also minimizes the risk of accidents.

// Extreme durability

LINE LIGHT is constructed by a closed "unbreakable" extruded acrylic profile which makes it extremely sturdy and shockproof to endure even strong strokes, shocks and vibrations from industrial machinery.

LINE LIGHT endures the rough, wet and dirty conditions of the professional working environment within the industry and is resistant to both oil and chemicals. The IP67 classification means that it is resistant to both dust and water. LINE LIGHT is completely maintenance free.

// Reduced power consumption

Compared to traditional fluorescent tube lighting, the electricity consumption is considerably reduced when using LINE LIGHT which presents serious cost savings on electricity.



// Dimmer

With the dimmer function it is possible to adjust the light intensity stepless from 1-100% to meet individual working conditions. LINE LIGHT 2-POST and LINE LIGHT 4 are delivered incl. dimmer, and can also be bought separately and retrofitted on all existing LINE LIGHT installations.

BEAM
ANGLE
75°



IP67



ULTRA
SLIM
DESIGN
Ø25mm

EU DESIGN
PATENT
1882523



NEW
Upgraded
product

FLEXIBLE lighting solution for 2-post lifts and mobile column lifts

ORIGINAL
SCANGRIP
SINCE 1906
MADE IN DENMARK

LINE LIGHT 2-POST is a universal all-in-one solution always available at hand and ready to use when needed.

The lighting unit can be positioned everywhere underneath the car with magnets and can be moved under the car to the actual repair work.

Due to the 5 m spiral cable, the lamp can easily be used for illumination around the entire car, or as a dedicated lamp for engine bay or wheel arch illumination.

- Fits all 2-post lifts and mobile column lifts regardless of type
- Powerful illumination providing 2 x 1250 lumen
- Easy and uncomplicated to mount
- No drilling in the lift construction
- Incl. DIMMER function

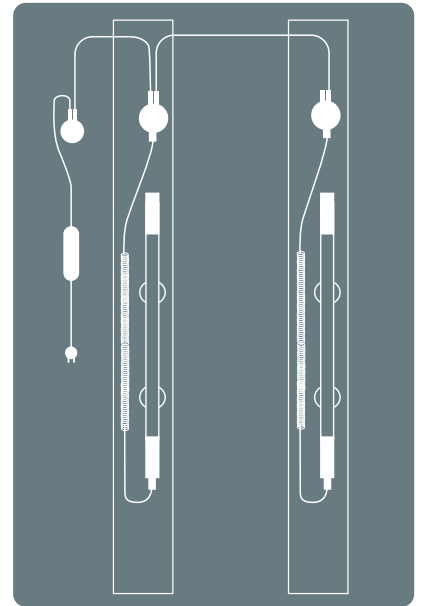

LINE LIGHT 2-POST

03.5225

NEW
Upgraded
version



FLEXIBLE MAGNETIC SUSPENSION



3
years
warranty

PATENT PROTECTED

NEW
Upgraded
product

COMPLETE lighting solution for automotive lifts

- Extremely powerful illumination of working area - improved lumen output
- Improve work efficiency and working conditions
- Avoid blinding the mechanic during work
- Adjustable lighting angle

// Compact design

Compared to traditional 36 W fluorescent tubes, LINE LIGHT provides an extremely bright and powerful illumination of the entire undercarriage. The slim and compact design leaves space for the center jack to pass.

// Easy DIY installation

As LINE LIGHT is a low operating voltage (24 V DC) system, you can easily do the installation yourself. All basic fittings are supplied with each kit together with power supply and cable. The pre-defined LINE LIGHT kits are considered universal and will fit the majority of all automotive 4-post lifts, regardless of the manufacturer or brand.



BEAM ANGLE
75°



Blinding of the mechanic during work is avoided, and the lamp itself can be turned to provide the optimum lighting angle during work.



Example of LINE LIGHT solution mounted in a truck mechanic's pit

LINE LIGHT 1

NEW
Upgraded
version

03.5203

1 complete lighting unit 1630 mm incl. 25 W power supply, cable and suspension providing 2750 lumen

LINE LIGHT 2

NEW
Upgraded
version

03.5202

2 complete lighting units 1234 mm each providing 2000 lumen, incl. 80 W power supply, cable and suspension

LINE LIGHT 4

NEW
Upgraded
version

03.5201

4 complete lighting unit 1630 mm each providing 2750 lumen, incl. 80 W power supply, cable, suspension and dimmer function

LINE LIGHT 6

NEW
Upgraded
version

03.5200

6 complete lighting units 1630 mm each providing 2750 lumen, incl. 2 pcs 80 W power supply, cable and suspension



FLEXIBLE lighting units for customized installations

The LINE LIGHT lighting units are available in different lengths which can either be used alone or connected in a string to fit all kinds of application.

The lighting units can be combined exactly the way you want offering a flexible lighting solution.

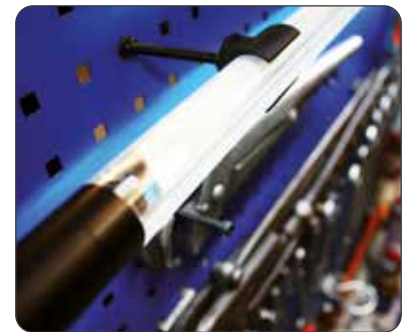
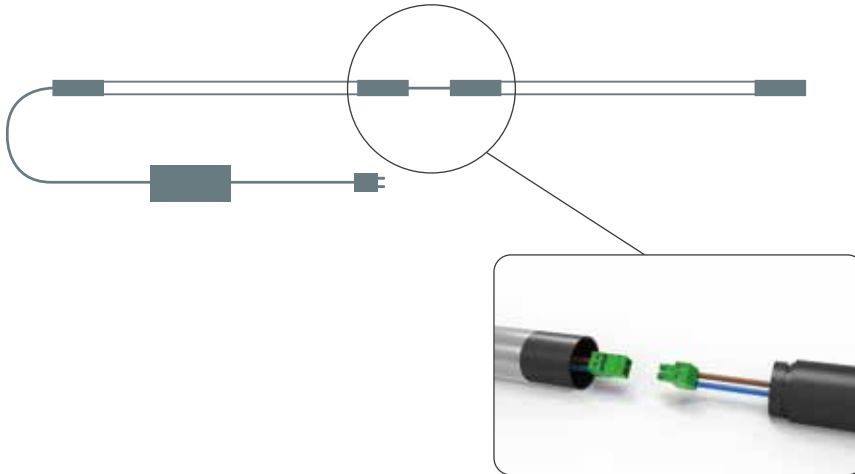

// Flexibility that meets your specific needs

Combine lighting units with power supply, cable and suitable suspensions. A range of flexible suspensions makes it possible to position the lighting units exactly where you need it.

DESIGN YOURSELF



LINE LIGHT 75



Upgraded version

03.5221

Lighting unit 838 mm providing 1250 lumen



LINE LIGHT 120



Upgraded version

03.5222

Lighting unit 1234 mm providing 2000 lumen



LINE LIGHT 160



Upgraded version

03.5223

Lighting unit 1630 mm providing 2750 lumen



LINE LIGHT 200



Upgraded version

03.5224

Lighting unit 2027 mm providing 3500 lumen

3 years warranty

PATENT PROTECTED



MAG series



	MAG PEN 3	MINI MAG PRO	MAG	MAG PRO
Product number	03.5116	03.5692	03.5400	03.5690
Light source	COB LED Spot: CREE XP-G2	COB LED Spot: High power LED	10 SMD LEDs Spot: High power LED	COB LED Spot: High power LED
LED performance, lumen/W	180	165	118	185
Luminous flux, lumen	15-150 Spot: 80	20-200 Spot: 80	150-300 Spot: 80	60-600 Spot: 150
Illuminance, lux@0.5 m	200 Spot: 2000	35-350 Spot: 700	250-500 Spot: 850	90-900 Spot: 2000
Adjustable light output	Stepless	Stepless	2 levels	Stepless
CRI	Ra > 80	Ra > 80	Ra > 80	Ra > 80
CCT	6000 K	6000K K	6000 K	6000 K
Operating time with max. lumen, h	2	2	2.5	1.5
Operating time with min. lumen, h	20	20	5	15
Charging time, h	3.5	3	4	4
Battery	3.7V / 750 mAh Li-ion	3.7V / 1200 mAh Li-ion	3.7V / 2200 mAh Li-ion	3.7V / 2600 mAh Li-ion
Protection class	IP20	IP54	IP20	IP54
Impact protection	IK07	IK07	IK07	IK07
Impact resistance	1 m	1 m	1 m	1 m
Cable	1 m USB	1 m USB	1 m USB	1 m USB
Operating voltage AC	-	-	-	-
Charging voltage/current DC	5 V / 1 A	5 V / 1 A	5 V / 1 A	5 V / 1 A
Power consumption	Max 2.5 W	Max 2.5 W	Max 3.5 W	Max 6.5 W
Charger incl.	No	No	Country depended	Country depended
Temperature	-10° to +40°C	-10° to +40°C	-10° to +40°C	-10° to +40°C
Dimensions	174 x 31 x 21 mm	200 x 40 x 28 mm	260 x 61 x 43 mm	261 x 62 x 43 mm
Net weight	78 g	157 g	252 g	339 g

UNIFORM series



	UNIPEN	MINIFORM	UNIFORM	SUPERFORM	UV-FORM
Product number	03.5420	03.5404	03.5407	03.5406	03.5408
Light source	COB LED Spot: High power LED	COB LED Spot: High power LED	COB LED Spot: High power LED	COB LED	COB LED Spot: High power UV-light
LED performance, lumen/W	125	165	150	130	128
Luminous flux, lumen	75-150 Spot: 75	100-200 Spot: 120	250-500 Spot: 175	750	125-250 Spot: UV
Illuminance, lux@0.5 m	125-250 Spot: 900	100-200 Spot: 800	475-950 Spot: 6000	1000	200-400 Spot: UV
Adjustable light output	2 levels	2 levels	2 levels	No	2 levels
Beam angle	-	110°	-	-	-
CRI	Ra > 80	Ra > 80	Ra > 80	Ra > 80	Ra > 80
CCT	6000 K	6000 K	6000 K	6000 K	6000 K
Operating time with max. lumen, h	2	3	2	-	2.5
Operating time with min. lumen, h	4	6	4.5	-	5
Charging time, h	2.5	3	5	-	3
Battery	3.7V / 750 mAh Li-ion	3.7V / 1600 mAh Li-ion	3.6V / 3000 mAh Li-ion	-	3.7V / 1600 mAh Li-ion
Protection class	IP65	IP65	IP65	IP54	IP20
Impact protection	IK07	IK07	IK07	IK08	IK07
Impact resistance	1 m	1 m	1 m	1 m	1 m
Cable	1 m USB	1 m USB	1 m USB	5 m H05RN-F 2x1 mm ²	1 m USB
Operating voltage AC	-	-	-	100-240 V	-
Charging voltage/current DC	5 V / 1 A	5 V / 1 A	5 V / 1 A	-	5 V / 1 A
Power consumption	Max 1.5 W	Max 2.5 W	Max 6 W	Max 8 W	Max 3 W
Charger incl.	No	Country depended	Country depended	-	Country depended
Temperature	-10° to +40°C	-10° to +40°C	-10° to +40°C	-10° to +40°C	-10° to +40°C
Dimensions	155 x 27 x 21 mm	122 x 60 x 28 mm	190 x 60 x 32 mm	270 x 49 x 31 mm	155 x 60 x 32 mm
Net weight	80 g	130 g	263 g	710 g	156 g

SLIM series



	MINI SLIM	SLIM
Product number	03.5610	03.5612
Light source	COB LED Spot: High power LED	COB LED Spot: High power LED
LED performance, lumen/W	170	155
Luminous flux, lumen	100-200 spot: 100	250-500 spot: 100
Illuminance, lux@0.5 m	150-400 spot: 5200	400-800 spot: 4800
Adjustable light output	2 levels	2 levels
CRI	Ra > 80	Ra > 80
CCT	6000 K	6000 K
Operating time with max. lumen, h	2.5	2.5
Operating time with min. lumen, h	5	5
Charging time, h	3	4.5
Battery	3.7V/1200 mAh Li-ion	3.6V/3000 mAh Li-ion
Protection class	IP30	IP30
Impact protection	IK07	IK07
Impact resistance	1 m	1 m
Cable	1 m USB	1 m USB
Operating voltage AC	-	-
Charging voltage/current DC	5 V / 1 A	5 V / 1 A
Power consumption	Max 2 W	Max 4 W
Charger incl.	Country depended	Country depended
Temperature	-10° to +40°C	-10° to +40°C
Dimensions	132 x 41 x 30 mm	165 x 44 x 28 mm
Net weight	101 g	224 g

LINE LIGHT inspection



	LINE LIGHT C+R <small>Upgraded</small>	LINE LIGHT R <small>Upgraded</small>
Product number	03.5243	03.5244
Light source	36 SMD LED Spot: CREE XP-G2	20 SMD LED Spot: CREE XP-G2
LED performance, lumen/W	189	189
Luminous flux, lumen	900 Spot: 150	600 Spot: 150
Illuminance, lux@0.5 m	1800 Spot: 1500	1200 Spot: 1500
Adjustable light output	No	No
Beam angle	75° Spot: 50°	75° Spot: 50°
CRI	Ra > 80	Ra > 80
CCT	6500 K	6500 K
Operating time with max. lumen, h	2.5 Spot: 8	1.5 Spot: 4
Operating time with min. lumen, h	-	-
Charging time, h	4	6
Battery	3.7V / 5200 mAh Li-ion	3.7V / 2600 mAh Li-ion
Protection class	IP65	IP65
Impact protection	IK07	IK07
Impact resistance	1 m	1 m
Cable	5 m / 2x1 mm ² HO5RN-F	1 m USB
Operating voltage AC	-	-
Charging voltage/current DC	4.2 V / 3.5 A	5 V / 1 A
Power consumption	Max 8 W	Max 5.5 W
Charger incl.	Yes	Country depended
Temperature	-10° to +40°C	-10° to +40°C
Dimensions	ø25 x 461 mm	ø25 x 357 mm
Net weight	300 g	220 g

BONNET LIGHTS



	LINE LIGHT BONNET C+R <small>Upgraded</small>	NOVA BONNET
Product number	03.5240	03.5457
Light source	64 SMD LED	High efficiency COB LED
LED performance, lumen/W	189	160
Luminous flux, lumen	700-1400	200-2000
Illuminance, lux@0.5 m	1000-2000	300-3000
Adjustable light output	2 levels	5 levels
Beam angle	75°	-
CRI	Ra > 80	Ra > 80
CCT	6500 K	6000 K
Operating time with max. lumen, h	1.5	2
Operating time with min. lumen, h	3	20
Charging time, h	4	5
Battery	3.7V / 5200 mAh Li-ion	7.3V / 4000 mAh Li-ion
Protection class	IP65	IP67
Impact protection	IK07	IK07
Impact resistance	1 m	1 m
Cable	5 m / 2x1.0 mm ² HO5RN-F	1 m USB
Operating voltage AC	-	-
Charging voltage/current DC	4.2 V / 3.5 A	5 V / 2 A
Power consumption	Max 13 W	Max 16 W
Charger incl.	Yes	Yes
Temperature	-10° to +40°C	-10° to +40°C
Dimensions	ø25 x 1017 mm	1135 x 220 x 163 mm
Net weight	470 g (980 g incl. rack)	1.69 kg (NOVA R 790 g)

Headlamps



	ZONE	I-VIEW NEW	NIGHT VIEW
Product number	03.5426	03.5626	03.5438
Light source	COB LED	COB LED	Ultra high CRI + COB LED
LED performance, lumen/W	160	175	100
Luminous flux, lumen	75-150	40-400	80-160
Illuminance, lux@0.5 m	200-400	100-1000	250-500
Adjustable light output	2 levels	Stepless	2 levels
Beam angle	120° / 60°	120° / 60°	120° / 60°
CRI	Ra > 80	Ra > 80	Ra > 80
CCT	6000 K	6000 K	6000 K RED 632nm
Operating time with max. lumen, h	2	1.5	2.5
Operating time with min. lumen, h	4	15	5
Charging time, h	3	3.5	4
Battery	3.7V/800 mAh Li-ion	3.8V / 1600 mAh Li-ion	3.8V / 1600 mAh Li-ion
Protection class	IP30	IP65	IP65
Impact protection	IK07	IK07	IK07
Impact resistance	1 m	1 m	1 m
Cable	1 m USB	1 m USB	1 m USB
Operating voltage AC	-	-	-
Charging voltage/current DC	5 V / 1 A	5 V / 1 A	5 V / 1 A
Power consumption	Max 2W	Max 3.25 W	Max 3 W
Charger incl.	No	No	Country depended
Temperature	-10° to +40°C	-10° to +40°C	-10° to +40°C
Dimensions	97 x 31 x 28 mm	100 x 50 x 38 mm	105 x 52 x 43 mm
Net weight	66 g	100 g	130 g

POWERBANK NEW
03.5782
-
-
-
-
-
-
-
-
-
-
3
3.65 V / 4000 mAh
IP20
IK07
1 m
Spiral cable
-
5 V / 2 A
Max 8 W
-
-10° to +40°C
ø28 x 103 mm
132 g

STAR



	STAR
Product number	03.5620
Light source	COB LED
LED performance, lumen/W	140
Luminous flux, lumen	500-1000
Illuminance, lux@0.5 m	800-1600
Adjustable light output	2 levels
Beam angle	-
CRI	Ra > 80
CCT	6000 K
Operating time with max. lumen, h	2.5
Operating time with min. lumen, h	5
Charging time, h	8
Battery	3.7V/5200 mAh Li-ion
Protection class	IP65
Impact protection	IK07
Impact resistance	1 m
Cable	1 m USB
Operating voltage AC	-
Charging voltage/current DC	5 V / 1 A
Power consumption	Max 8.5 W
Charger incl.	Country depended
Temperature	-10° to +40°C
Dimensions	156 x 103 x 98 mm
Net weight	620 g



NOVA rechargeable series



	NOVA MINI	NOVA R	NOVA 4K C+R	NOVA 6K C+R
Product number	03.6010	03.5456	03.5441	03.5443
Light source	High efficiency COB LED	High efficiency COB LED	High efficiency COB LED	High efficiency COB LED
LED performance, lumen/W	155	160	170	160
Luminous flux, lumen	100-1000	200-2000	400-4000	600-6000
Illuminance, lux@0.5 m	150-1500	300-3000	500-5000	800-8000
Adjustable light output	Stepless	5 levels	5 levels	5 levels
CRI	Ra > 80	Ra > 80	Ra > 80	Ra > 80
CCT	6000 K	6000 K	6000 K	6000 K
Operating time with max. lumen, h	1.5	2	1	1
Operating time with min. lumen, h	15	20	14	12
Charging time, h	5	5	2	2
Battery	3.65V / 4000 mAh	7.3V / 4000 mAh Li-ion	11.1V / 4400 mAh Li-ion	11.1V / 5200 mAh Li-ion
Protection class	IP65	IP67	IP67	IP67
Impact protection	IK07	IK07	IK07	IK07
Impact resistance	1 m	1 m	1 m	1 m
Cable	1 m USB	1 m USB	5 m / 2x0,75 mm ² H05RN-F	5 m / 2x0,75 mm ² H05RN-F
Operating voltage AC		-		-
Charging voltage/current DC	5 V / 1 A	5 V / 2 A	12.6 V / 2.4 A	12.6 V / 4.3 A
Power consumption	Max 10 W	Max 16 W	Max 29 W	Max 42 W
Charger incl.	No	Yes	Yes	Yes
Temperature	-10° to +40°C	-10° to +40°C	-10° to +40°C	-10° to +40°C
Dimensions	104 x 38 x 96 mm	163 x 63 x 163 mm	235 x 88 x 233 mm	267 x 87 x 262 mm
Net weight	254 g	790 g	2.3 kg	2.91 kg

NOVA cable series



	NOVA 4K <small>Upgraded</small>	NOVA 6K <small>Upgraded</small>	NOVA 12K <small>Upgraded</small>
Product number	03.5440	03.5442	03.5444
Light source	High efficiency COB LED	High efficiency COB LED	High efficiency COB LED
LED performance, lumen/W	160	160	170
Luminous flux, lumen	400-4000	600-6000	1200-12000
Illuminance, lux@0.5 m	600-6000	900-9000	1800-18000
Adjustable light output	5 levels	5 levels	5 levels
CRI	Ra > 80	Ra > 80	Ra > 80
CCT	6000 K	6000 K	6000 K
Operating time with max. lumen, h	-	-	-
Operating time with min. lumen, h	-	-	-
Battery	-	-	-
Protection class	IP67	IP67	IP67
Impact protection	IK07	IK07	IK07
Impact resistance	1 m	1 m	1 m
Cable	5 m / 3x1 mm ² H05RN-F	5 m / 3x1 mm ² H05RN-F	5 m / 3x1 mm ² H05RN-F
Operating voltage AC	100-240 V	100-240 V	100-240 V
Charging voltage/current DC	-	-	-
Power consumption	Max 30 W	Max 42 W	Max 86 W
Charger incl.	-	-	-
Temperature	-10° to +40°C	-10° to +40°C	-10° to +40°C
Dimensions	235 x 88 x 233 mm	267 x 87 x 262 mm	302 x 102 x 298 mm
Net weight	2.38 kg	2.66 kg	4 kg

NOVA SPS series



AREA 10 SPS



	NOVA 4 SPS	NOVA 6 SPS	NOVA 10 SPS	AREA 10 SPS
Product number	03.6000	03.6001	03.6002	03.6009
Light source	High efficiency COB LED	High efficiency COB LED	High efficiency COB LED	224 SMD LEDs
LED performance, lumen/W	175	185	185	177
Luminous flux, lumen	400-4000	600-6000	1000-10000	360°: 1000-10000 / 180°: 500-5000
Illuminance, lux@0.5 m	600-6000	900-9000	1600-16000	300-30000
Adjustable light output	5 levels	5 levels	5 levels	5 levels
Beam angle	115°	115°	115°	360° / 180°
CRI	Ra > 80	Ra > 80	Ra > 80	Ra > 80
CCT	6000 K	6000 K	6000 K	6000 K
Operating time with max. lumen, h	1.5	2	1	360°: 1 / 180°: 2
Operating time with min. lumen, h	15	20	10	360°: 10 / 180°: 20
Charging time, h	1.5*	2*	1.5*	2*
Battery	11.1V / 4000 mAh Li-ion	11.1V / 8000 mAh Li-ion	11.1V / 8000 mAh Li-ion	11.1V / 8000 mAh Li-ion
Protection class	IP67	IP67	IP67	IP65
Impact protection	IK07	IK07	IK07	IK07
Impact resistance	1 m	1 m	1 m	1 m
Charging voltage/current DC	12.6 V / 2.8 A	12.6 V / 4 A	12.6 V / 6.8 A	12.6 V / 6.8 A
Power consumption	Max 30 W	Max 45 W	Max 75 W	Max 84 W
Battery incl.	SPS BATTERY 03.6003	SPS BATTERY 03.6004	SPS BATTERY 03.6004	SPS BATTERY 03.6004
Charger incl.	SPS CHARGING SYSTEM 35W 03.6006	SPS CHARGING SYSTEM 50W 03.6007	SPS CHARGING SYSTEM 85W 03.6008	SPS CHARGING SYSTEM 85W 03.6008
Temperature	-10° to +40°C	-10° to +40°C	-10° to +40°C	-10° to +40°C
Dimensions	240 x 230 x 104 mm	270 x 260 x 120 mm	305 x 290 x 125 mm	380 x 198 x 198 mm
Net weight	1.97 kg	2.69 kg	3.6 kg	3.8 kg

* 80%

SCANGRIP POWER SOLUTION accessories



	SPS BATTERY 4Ah	SPS BATTERY 8Ah	SPS CHARGING SYSTEM 35W	SPS CHARGING SYSTEM 50W	SPS CHARGING SYSTEM 85W
Product number	03.6003	03.6004	03.6006	03.6007	03.6008
Battery	11.1 V / 4000 mAh Li-ion	11.1 V / 8000 mAh Li-ion	-	-	-
Charging voltage, current DC	12.6 V / 2.8 A	12.6 V / 6.8 A	12.6 V / 2.8 A	12.6 V / 4 A	12.6 V / 6.8 A
Cable	-	-	5 m / 2x0,75 mm ² H05RN-F	5 m / 2x0,75 mm ² H05RN-F	5 m / 2x0,75 mm ² H05RN-F
Charger input voltage	-	-	100-240V AC 50/60Hz	100-240V AC 50/60Hz	100-240V AC 50/60Hz
Power consumption	-	-	Max 35 W	Max 50 W	Max 85 W
Charging time, h	1.5*	1.5*	-	-	-
Protection class	IP67	IP67	IP67	IP67	IP67
Impact protection	IK07	IK07	IK07	IK07	IK07
Impact resistance	1 m	1 m	1 m	1 m	1 m
Temperature	-10° to +40°C	-10° to +40°C	-10° to +40°C	-10° to +40°C	-10° to +40°C
Dimensions	103 x 75 x 40 mm	103 x 75 x 62 mm	139 x 75 x 40 mm	139 x 75 x 49 mm	139 x 75 x 49 mm
Net weight	320 g	560 g	650 g	700 g	760 g

* 80%



Designed by us. Manufactured by us.

3
years
warranty

PATENT PROTECTED

NOVA 2 CONNECT



Product number	03.6100C
Light source	High efficiency COB LED
LED performance, lumen/W	165
Luminous flux, lumen	200-2000
Illuminance, lux@0.5 m	300-3000
Adjustable light output	5 levels
Beam angle	110°
CRI	Ra > 80
CCT	6000 K
Operating time with max. lumen, h	2.5@12V 4.0 Ah battery 5.75@18V 5.2 Ah battery
Operating time with min. lumen, h	27@12V 4.0 Ah battery 58@18V 5.2 Ah battery
Operating time: backup battery, h	-
Battery	Compatible with METABO / CAS battery system 12V, 14.4V, 18V
Protection class	IP30
Impact protection	IK07
Impact resistance	1 m
Charger input voltage	-
Power consumption	Max 16 W
Battery incl.	No
Charger incl.	No
Power supply Incl.	No
Temperature	-10° to +40°C
Dimensions	161 x 164 x 78 mm
Net weight	720g



NOVA 4 CONNECT



Incl. SCANGRIP DIFFUSER			
Product number	03.6101C	03.6130	03.6133
Light source	High efficiency COB LED	High efficiency COB LED	High efficiency COB LED
LED performance, lumen/W	160	160	160
Luminous flux, lumen	400-4000	400-4000	400-4000
Illuminance, lux@0.5 m	600-6000	600-6000	600-6000
Adjustable light output	5 levels	5 levels	5 levels
Beam angle	110°	110°	110°
CRI	Ra > 80	Ra > 80	Ra > 80
CCT	6000 K	6000 K	6000 K
Operating time with max. lumen, h	1.5@12V 4.0 Ah battery 3@18V 5.2 Ah battery	1.5@12V 4.0 Ah battery 3@18V 5.2 Ah battery	1.5@12V 4.0 Ah battery 3@18V 5.2 Ah battery
Operating time with min. lumen, h	14@12V 4.0 Ah battery 31@18V 5.2 Ah battery	14@12V 4.0 Ah battery 31@18V 5.2 Ah battery	14@12V 4.0 Ah battery 31@18V 5.2 Ah battery
Operating time: backup battery, h	2.5@10% /400 lm	2.5@10% /400 lm	2.5@10% /400 lm
Battery	Compatible with METABO / CAS battery system 12V, 14.4V, 18V	Compatible with METABO / CAS battery system 12V, 14.4V, 18V	Compatible with METABO / CAS battery system 12V, 14.4V, 18V
Protection class	IP65 IP54 with battery cover	IP65 IP54 with battery cover	IP65 IP54 with battery cover
Impact protection	IK07	IK07	IK07
Impact resistance	1 m	1 m	1 m
Charger input voltage	-	100-240V AC 50/60Hz	-
Power consumption	Max 30 W	Max 30 W	Max 30 W
Battery incl.	No	CAS BATTERY 12V 4.0 Ah 03.6120	No
Charger incl.	No	CAS CHARGER 03.6122	No
Power supply incl.	No	No	SCANGRIP POWER SUPPLY 03.6123
Temperature	-10° to +40°C	-10° to +40°C	-10° to +40°C
Dimensions	263x230x119mm	263x230x119mm	263x230x119mm
Net weight	2.35 kg	3.37 kg	3.35 kg



NOVA 10 CONNECT

Incl. SCANGRIP DIFFUSER



Product number	03.6102C	03.6131	03.6134
Light source	High efficiency COB LED	High efficiency COB LED	High efficiency COB LED
LED performance, lumen/W	165	165	165
Luminous flux, lumen	1000-10000	1000-10000	1000-10000
Illuminance, lux@0.5 m	1600-16000	1600-16000	1600-16000
Adjustable light output	5 levels	5 levels	5 levels
Beam angle	110°	110°	110°
CRI	Ra > 80	Ra > 80	Ra > 80
CCT	6000 K	6000 K	6000 K
Operating time with max. lumen, h	0.5@12V 4.0 Ah battery 1.25@18V 5.2 Ah battery	0.5@12V 4.0 Ah battery 1.25@18V 5.2 Ah battery	0.5@12V 4.0 Ah battery 1.25@18V 5.2 Ah battery
Operating time with min. lumen, h	5.5@12V 4.0 Ah battery 12@18V 5.2 Ah battery	5.5@12V 4.0 Ah battery 12@18V 5.2 Ah battery	5.5@12V 4.0 Ah battery 12@18V 5.2 Ah battery
Operating time: backup battery, h	1@10% / 1000 lm	1@10% / 1000 lm	1@10% / 1000 lm
Battery	Compatible with METABO / CAS battery system 12V, 14.4V, 18V	Compatible with METABO / CAS battery system 12V, 14.4V, 18V	Compatible with METABO / CAS battery system 12V, 14.4V, 18V
Protection class	IP65 IP54 with battery cover	IP65 IP54 with battery cover	IP65 IP54 with battery cover
Impact protection	IK07	IK07	IK07
Impact resistance	1 m	1 m	1 m
Charger input voltage	-	100-240V AC 50/60Hz	-
Power consumption	Max 75 W	Max 75 W	Max 75 W
Battery incl.	No	CAS BATTERY 18V 5.2 Ah 03.6121	No
Charger incl.	No	CAS CHARGER 03.6122	No
Power supply incl.	No	No	SCANGRIP POWER SUPPLY 03.6123
Temperature	-10° to +40°C	-10° to +40°C	-10° to +40°C
Dimensions	304x292x131mm	304x292x131mm	304x292x131mm
Net weight	3.72 kg	5.09 kg	4.72 kg



AREA 10 CONNECT



Product number	03.6103C	03.6132	03.6135
Light source	High efficiency COB LED		High efficiency COB LED
LED performance, lumen/W	189		189
Luminous flux, lumen	360°: 1000-10000 / 180°: 500-5000		360°: 1000-10000 / 180°: 500-5000
Illuminance, lux@0.5 m	300-3000		300-3000
Adjustable light output	5 levels		5 levels
Beam angle	360° / 180°		360° / 180°
CRI	Ra > 80		Ra > 80
CCT	6000 K		6000 K
Operating time with max. lumen, h	0.5@12V 4.0 Ah battery 1@18V 5.2 Ah battery		0.5@12V 4.0 Ah battery 1@18V 5.2 Ah battery
Operating time with min. lumen, h	10@12V 4.0 Ah battery 22@18V 5.2 Ah battery		10@12V 4.0 Ah battery 22@18V 5.2 Ah battery
Operating time: backup battery, h	50min@10% / 1000 lm		50min@10% / 1000 lm
Battery	Compatible with METABO / CAS battery system 12V, 14.4V, 18V		Compatible with METABO / CAS battery system 12V, 14.4V, 18V
Protection class	IP65 IP54 with battery cover		IP65 IP54 with battery cover
Impact protection	IK07		IK07
Impact resistance	1 m		1 m
Charger input voltage	-		100-240V AC 50/60Hz
Power consumption	Max 84 W		Max 84 W
Battery incl.	No		CAS BATTERY 18V 5.2 Ah 03.6121
Charger incl.	No		CAS CHARGER 03.6122
Power supply incl.	No		SCANGRIP POWER SUPPLY 03.6123
Temperature	-10° to +40°C		-10° to +40°C
Dimensions	395x200x212mm		395x200x212mm
Net weight	3.7 kg		5.07 kg

SCANGRIP CAS Accessories



















	CAS BATTERY 12V LiHD 4.0Ah	CAS BATTERY 18V Li-POWER 5.2Ah	CAS CHARGER SC30	SCANGRIP POWER SUPPLY
Product number	03.6120	03.6121	03.6122	03.6123
Battery	12V 4.0Ah Li-ion	18V 5.2Ah Li-power	-	-
Cable	-	-	1.35m 2x0.75mm2 H03V VH2-F	5m 2x0.75mm2 H05RN-F
Charger input voltage	-	-	220-240V AC 50/60Hz	100-240V AC 50/60Hz
Output power	-	-	Max 30 W	Max 90 W
Charging time, h	92min@100% with CAS charger 03.6122	208min@100% with CAS charger 03.6122	-	-
Protection class	IP20	IP20	IP20	IP65
Impact protection	-	-	-	IK07
Impact resistance	-	-	-	1 m
Temperature	-10° to +40°C	-10° to +40°C	0° to +40°C	-10° to +40°C
Dimensions	88x75x40mm	121x80.5x66mm	150x140x75mm	124x83x72mm
Net weight	325 g	670 g	700 g	1 kg
Compatibility	-	-	12V-18V CAS battery	12V-18V SCANGRIP CAS work lights



Compatible with
METABO / CAS
battery system
12V - 18V

WORK LIGHTS - CAS RANGE

NOVA 2 CONNECT	03.6100C 		
NOVA 4 CONNECT	03.6101C 	03.6130  + 	03.6133  + 
NOVA 10 CONNECT	03.6102C 	03.6131  + 	03.6134  + 
AREA 10 CONNECT	03.6103C 	03.6132  + 	03.6135  + 

SITE LIGHT series



	SITE LIGHT 40 Upgraded	SITE LIGHT 80 Upgraded
Product number	03.5268	03.5269
Light source	432 SMD LEDs	864 SMD LEDs
LED performance, lumen/W	189	189
Luminous flux, lumen	10000-40000	20000-80000
Illuminance, lux@0.5 m	-	-
Adjustable light output	4 levels	4 levels
Beam angle	120°	120°
CRI	Ra > 80	Ra > 80
CCT	6000 K	6000 K
Operating time with max. lumen, h	-	-
Operating time with min. lumen, h	-	-
Charging time, h	-	-
Battery	-	-
Protection class	IP65	IP65
Impact protection	IK08	IK08
Impact resistance	1 m	1 m
Cable	10 m / 3x1 mm ² H07RN-F	10 m / 3x1 mm ² H07RN-F
Operating voltage AC	220-240 V	220-240 V
Charging voltage/current DC	-	-
Power consumption	Max 315 W	Max 630 W
Charger incl.	-	-
Temperature	-25° to +40°C	-25° to +40°C
Dimensions	278 x 241 x 160 mm	415 x 241 x 160 mm
Net weight	4.95 kg	6.70 kg





FLASH MICRO R FLASH series

	FLASH MICRO R	FLASH PENCIL	FLASH PEN	FLASH 300	FLASH 600
Product number	03.5113	03.5130	03.5131	03.5132	03.5133
Light source	LED	LUMILEDS	CREE	CREE	CREE
LED performance, lumen/W	103	124	142	165	165
Luminous flux, lumen	7.5-75	75	100-200	150-300	300-600
Illuminance, lux@0.5 m	2.5	1500	500-8000	600-10000	1000-20000
Adjustable light output	Stepless	No	BOOST mode	BOOST mode	BOOST mode
Beam angle	110°	15°	10°-60°	10°-60°	10°-60°
Beam distance	10 m	40 m	80 m	100 m	150 m
CRI	Ra > 80	Ra > 70	Ra > 70	Ra > 65	Ra > 65
CCT	6000 K	6000 K	6000 K	6000 K	6000 K
Operating time with max. lumen, h	0.25	2.5	3.5	3	2
Operating time with min. lumen, h	2.5	-	-	-	-
Charging time, h	2.5	-	-	-	-
Battery	3.7 V / 100 mAh Li-ion	2xAAAA / 1.5 V Alkaline	2xAAA / 1.5 V Alkaline	3xAAA / 1.5 V Alkaline	2xC / 1.5 V Alkaline
Protection class	IP20	IP54	IP54	IP54	IP54
Impact protection	-	IK07	IK07	IK07	IK07
Impact resistance	1 m	1 m	1 m	1 m	1 m
Cable	USB cable	-	-	-	-
Charging voltage/current DC	-	-	-	-	-
Power consumption	Max 1.2 W	Max 1.6 W	Max 1.2 W	Max 4.8 W	Max 7 W
Charger incl.	-	-	-	-	-
Temperature	-10° to +40°C	-10° to +40°C	-10° to +40°C	-10° to +40°C	-10° to +40°C
Dimensions	55 x 15 x 25mm	ø15 x 131mm	ø20 x 153mm	ø32 x 133mm	ø36 x 174mm
Net weight	17 g	32 g	62 g	122 g	292 g

FLASH R series



	FLASH 12-24V	WORK PEN 200 R	FLASH PEN R	FLASH 600 R	FLASH 1000 R
Product number	03.5124	03.5127	03.5136	03.5137	03.5138
Light source	SAMSUNG LED	COB LED / CREE	CREE	CREE	CREE
LED performance, lumen/W	140	120	165	165	148
Luminous flux, lumen	130	20-200 Spot: 150	150-300	300-600	500-1000
Illuminance, lux@0.5 m	900-8000	400 Spot: 3500	600-10000	1000-20000	3000-60000
Adjustable light output	No	Stepless	BOOST mode	BOOST mode	BOOST mode
Beam angle	10°-70°	105° / 20°	10°-60°	10°-70°	10°-60°
Beam distance	100 m	40 m	100 m	150 m	250 m
CRI	Ra > 70	Ra > 80	Ra > 65	Ra > 65	Ra > 70
CCT	6000 K	6000 K	6000 K	6000 K	6000 K
Operating time with max. lumen, h	1	1	7	7	5
Operating time with min. lumen, h	-	10	-	-	-
Charging time, h	2	2.5	3	4	4
Battery	3.7 V / 550 mAh Li-ion	3.7 V / 750 mAh Li-ion	3.7V / 1100 mAh Li-ion	3.7V / 2600 mAh Li-ion	3.7V / 4000 mAh Li-ion
Protection class	IP30	IP30	IP54	IP54	IP54
Impact protection	IK07	IK07	IK07	IK07	IK07
Impact resistance	1 m	1 m	1 m	1 m	1 m
Cable	Cigarette Plug Connector	1 m USB	1 m USB	1 m USB	1 m USB
Charging voltage/current DC	10-28 V	5 V / 1 A	5 V / 1 A	5 V / 1 A	5 V / 2 A
Power consumption	Max 2 W	4 W	4 W	6 W	12 W
Charger incl.	No	No	No	No	No
Temperature	-10° to +40°C	-10° to +40°C	-10° to +40°C	-10° to +40°C	-10° to +40°C
Dimensions	ø30 x 105 mm	ø21 x 172 mm	ø24 x 169 mm	ø38 x 185 mm	ø42 x 196 mm
Net weight	88 g (100 g with cover)	54 g	83 g	253 g	345 g

LINE LIGHT series



	LINE LIGHT 2-POST Upgraded	LINE LIGHT 1 Upgraded	LINE LIGHT 2 Upgraded	LINE LIGHT 4 Upgraded	LINE LIGHT 6 Upgraded
Product number	03.5225	03.5203	03.5202	03.5201	03.5200
Light source	2 x 96 SMD LED	216 SMD LED	2 x 156 SMD LED	4 x 216 SMD LED	6 x 216 SMD LED
LED performance, lumen/W	189	189	189	189	189
Luminous flux, lumen	2 x 12.5-1250	2750	2 x 2000	4 x 2750	6 x 2750
Illuminance, lux@0.5 m	2 x 20-2000	3000	2 x 2800	4 x 27.5-2750	6 x 3000
Adjustable light output	Stepless	No	No	Stepless	No
Beam angle	75°	75°	75°	75°	75°
CRI	Ra > 80	Ra > 80	Ra > 80	Ra > 80	Ra > 80
CCT	6000 K	6000 K	6000 K	6000 K	6000 K
Operating time with max. lumen, h	-	-	-	-	-
Operating time with min. lumen, h	-	-	-	-	-
Charging time, h	-	-	-	-	-
Battery	-	-	-	-	-
Protection class	IP67	IP67	IP67	IP67	IP67
Impact protection	IK07	IK07	IK07	IK07	IK07
Impact resistance	1 m	1 m	1 m	1 m	1 m
Cable	8 m / H03VV-F 2x0.5 mm ²	8 m / H03VV-F 2x0.5 mm ²	8 m / H03VV-F 2x0.5 mm ²	8 m / H03VV-F 2x0.5 mm ²	8 m / H03VV-F 2x0.5 mm ²
Operating voltage AC	-	-	-	-	-
Charging voltage/current DC	24 V	24 V	24 V	24 V	24 V
Power consumption	Max 2 x 24 W	Max 26 W	Max 2 x 38 W	Max 4 x 104 W	Max 6 x 156 W
Power supply incl.	25 W POWER SUPPLY UNIT 03.5229	25 W POWER SUPPLY UNIT 03.5229	80 W POWER SUPPLY UNIT 03.5226	80 W POWER SUPPLY UNIT 03.5226	2 x 80 W POWER SUPPLY UNIT 03.5226
Temperature	-10° to +40°C	-10° to +40°C	-10° to +40°C	-10° to +40°C	-10° to +40°C
Dimensions	2 x ø25 x 770 mm	ø25 x 1630 mm	2 x ø25 x 1234 mm	4 x ø25 x 1630 mm	6 x ø25 x 1630 mm
Net weight*	4.1 kg	2.03 kg	4.52 kg	6.7 kg	10.24 kg

*Weight includes all parts and accessories included

LINE LIGHT series



	LINE LIGHT 75 Upgraded	LINE LIGHT 120 Upgraded	LINE LIGHT 160 Upgraded	LINE LIGHT 200 Upgraded
Product number	03.5221	03.5222	03.5223	03.5224
Light source	96 SMD LED	156 SMD LED	216 SMD LED	276 SMD LED
LED performance, lumen/W	189	189	189	189
Luminous flux, lumen	1250	2000	2750	3500
Illuminance, lux@0.5 m	2000	2800	3000	3200
Adjustable light output	No	No	No	No
Beam angle	75°	75°	75°	75°
CRI	Ra > 80	Ra > 80	Ra > 80	Ra > 80
CCT	6000 K	6000 K	6000 K	6000 K
Operating time with max. lumen, h	-	-	-	-
Operating time with min. lumen, h	-	-	-	-
Charging time, h	-	-	-	-
Battery	-	-	-	-
Protection class	IP67	IP67	IP67	IP67
Impact protection	IK07	IK07	IK07	IK07
Impact resistance	1 m	1 m	1 m	1 m
Cable	-	-	-	-
Operating voltage AC	-	-	-	-
Charging voltage/current DC	24 V	24 V	24 V	24 V
Power consumption	Max 10 W	Max 16 W	Max 22 W	Max 28 W
Power supply incl.	-	-	-	-
Temperature	-10° to +40°C	-10° to +40°C	-10° to +40°C	-10° to +40°C
Dimensions	ø25 x 838 mm	ø25 x 1234 mm	ø25 x 1630 mm	ø25 x 2027 mm
Net weight*	390 g	530 g	670 g	860 g

// Certified and strictly approved

SCANGRIP's expert staff make sure that our lights meet all standards and regulations. Our work lights are manufactured at our own factories and subject to strict quality controls in full compliance with local regulations. Our lights meet the highest standards and are certified according to EU's regulations, directives, and harmonized standards. We are ISO9001 certified by Bureau Veritas.

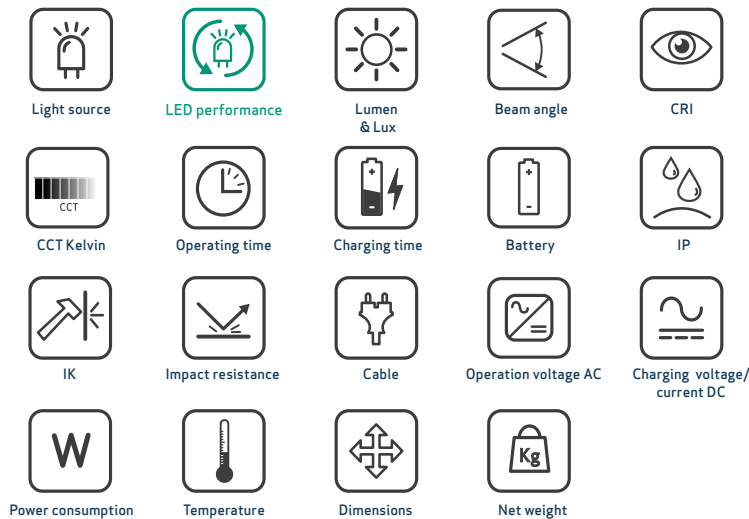

// Chargers for all countries

Electrical plugs and voltages differ from country to country around the world. SCANGRIP offers chargers to all country variants worldwide. Go to our website for a complete list of chargers for our rechargeable work lights and all other accessories available.



Combine LINE LIGHT lighting units with power supply, cable and suitable suspensions.

A range of flexible suspensions makes it possible to position the lighting units exactly where you need it.

POWER SUPPLY/CABLE		Product number
	LINE LIGHT DIMMER	03.5264
2m cable 5m cable	25 W power supply unit	03.5229
2m cable 5m cable	80 W power supply unit	03.5226
	POWER CABLE 8 m	03.5215

SUSPENSIONS		Product number
	CLIP - 1 pc. - incl. fittings for suspension	03.5214
	CLIP - 1 pc. - incl. fittings for suspension	03.5216
	LARGE MAGNET - ø60 mm with clip	03.5276
	FLEXIBLE MAGNET SUSPENSION - Ball socket joint with strong magnet for suspension for LINE LIGHT 2-POST	03.5257
	MAGNET - With small clip - ø30 mm	03.5246
	CLIP - Small metal clip	03.5213

One lighting solution for all battery packs

JUST CONNECT

Compatible with BERNER - BOSCH - BOSCH GREEN - DEWALT - EINHELL - FEIN - FESTOOL

FLEX - HAZET - HIKOKI - INGERSOLL - MAKITA - METABO - MILWAUKEE - RIDGID - SNAP-ON - WÜRTH



With the new SCANGRIP CONNECT series, we have created a range of hybrid and innovative work lights compatible across all leading power tool brands - an outstanding lighting solution never seen before!

We connect the world of power tool batteries and professional work lights providing complete freedom to use a SCANGRIP work light regardless of your battery brand preference.

NEW

// Maximal freedom

The SCANGRIP CONNECT range is compatible with the METABO/CAS battery system and all other 18V battery packs from leading power tools brands. As something unique, we also offer a POWER SUPPLY which can be used for direct power providing unlimited availability to light. With stands and suspensions available, the work lights can be placed anywhere you need efficient lighting offering complete flexibility at the worksite.

Use your 18V battery pack for SCANGRIP CONNECT work lights



Compatible with **METABO / CAS** battery system
For METABO / CAS no connector is required

**BERNER - BOSCH - BOSCH GREEN - DEWALT - EINHELL - FEIN - FESTOOL - FLEX - HAZET
HIKOKI - INGERSOLL - MAKITA - METABO - MILWAUKEE- RIDGID - SNAP-ON - WÜRTH**

SCANGRIP PRODUCT LINES



Professional range of work lights with unmatched value for money



Specialized work lights for the painting industry



Explosion proof lights



One lighting solution for all battery packs



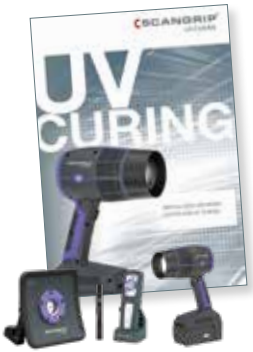

Portable lights for fast curing



3
years
warranty
PATENT PROTECTED

Designed by us. Manufactured by us.



SCANGRIP is Europe's leading manufacturer of work lights for professionals providing the strongest and most comprehensive ranges of work lights with the latest LED lighting technology available on the market.

SCANGRIP is innovation from Denmark and receives strong recognition in the marketplace for its product design, and the products are known for their high quality.

SCANGRIP strives for perfection, and is continuously optimizing and improving light output, battery capacity, design and ergonomics, durability, user-friendliness, and functionality. The aim is to set new standards for professional work lights.

SCANGRIP was established in 1906 and has a long, impressive history of manufacturing high-quality hand tools and work lights for the industrial, construction, and automotive sectors.

SCANGRIP is part of Hultafors Group - a global company offering a unique portfolio of premium brands within personal protection, tools, and other equipment for discerning craftsmen. Together, we are on a mission to create a better day for professional users.